



ETA-Danmark A/S
Göteborg Plads 1
DK-2150 Nordhavn
Tel. +45 72 24 59 00
Fax +45 72 24 59 04
Internet www.etadanmark.dk

Authorised and notified according
to Article 29 of the Regulation (EU)
No 305/2011 of the European
Parliament and of the Council of 9
March 2011

MEMBER OF EOTA



European Technical Assessment ETA-23/0235 of 2023/04/24

I General Part

Technical Assessment Body issuing the ETA and designated according to Article 29 of the Regulation (EU) No 305/2011: ETA-Danmark A/S

Trade name of the construction product:

ESSVE Joist Hangers

Product family to which the above construction product belongs:

Three-dimensional nailing plate (Joist hanger for wood to wood connections and wood to concrete or steel connections)

Manufacturer:

ESSVE Produkter AB
Esbogatan 14
SE-164 74 Kista
Internet www.essve.se

Manufacturing plant:

ESSVE Produkter AB
Manufacturing plant 926

This European Technical Assessment contains:

35 pages including 3 annexes which form an integral part of the document

This European Technical Assessment is issued in accordance with Regulation (EU) No 305/2011, on the basis of:

EAD 130186-00-0603 - Three dimensional nailing plates

This version replaces:

Translations of this European Technical Assessment in other languages shall fully correspond to the original issued document and should be identified as such.

Communication of this European Technical Assessment, including transmission by electronic means, shall be in full (excepted the confidential Annex(es) referred to above). However, partial reproduction may be made, with the written consent of the issuing Technical Assessment Body. Any partial reproduction has to be identified as such.

II SPECIFIC PART OF THE EUROPEAN TECHNICAL ASSESSMENT

1 Technical description of product

ESSVE joist hangers are one-piece non-welded, face-fixed joist hangers to be used in timber to timber connections as well as connections between a timber joist and a concrete structure or a steel member.

The joist hangers are made from pre-galvanized steel DX 51 D / Z 275 according to EN 10346:2015 with minimum yield strength $R_e \geq 250 \text{ N/mm}^2$, and minimum tensile strength $R_m \geq 360 \text{ N/mm}^2$ and minimum ultimate strain $A_{80} \geq 22\%$. Dimensions, hole positions, steel type and typical installations are shown in Annex A.

2 Specification of the intended use in accordance with the applicable European Assessment Document (hereinafter EAD)

The joist hangers are intended for use in making end-grain to side-grain connections in load bearing timber structures, as a connection between a wood based joist and a solid timber or wood based header, where requirements for mechanical resistance and stability and safety in use in the sense of the Basic Works Requirements 1 and 4 of Regulation (EU) 305/2011 shall be fulfilled.

The joist hangers can be installed as connections between wood based members such as:

- Structural solid timber classified to C14-C40 according to EN 338 / EN 14081,
- Glulam classified to GL24-GL36 according to EN 1194 / EN 14080,
- LVL according to EN 14374,
- Parallam PSL,
- Intrallam LSL,
- Duo- and Triobalken,
- Cross laminated timber,
- I-beams with backer blocks on both sides of the web in the header and web stiffeners in the joist
- Plywood according to EN 636

However, the calculation methods are only allowed for a characteristic wood density of up to 460 kg/m^3 . Even though the wood based material may have a larger density, this must not be used when calculating the load-carrying capacities of the fasteners.

Annex B states the formulas for the characteristic load-

carrying capacities of the joist hanger connections.

The design of the connections shall be in accordance with Eurocode 5 or a similar national Timber Code.

It is assumed that the forces acting on the joist hanger connection are F_{up} , F_{down} and F_{lat} , as shown in the figure below. The forces F_{up} and F_{down} shall act in the middle of the joist hanger. The force F_{lat} is assumed to act $e_{1,90}$ above the centre of gravity of the nails in the joist. It is assumed that the forces are acting right at the end of the joist.

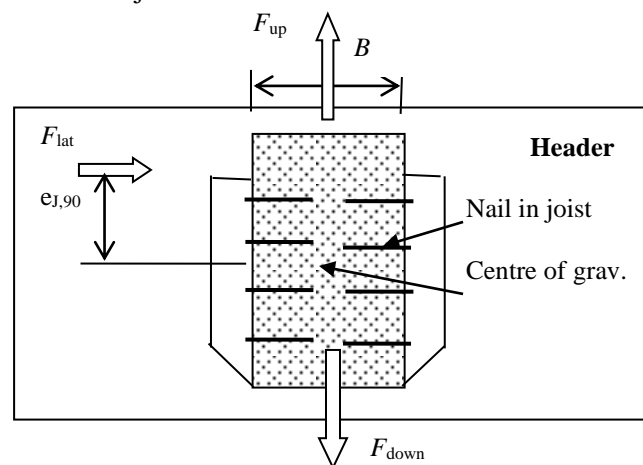

It is assumed that the header is prevented from rotating. Similar it is assumed that the concrete structure or the steel member, to which the joist hanger is bolted, does not rotate. If the header beam only has installed a joist hanger on one side, the eccentricity moment $M_v = F_d \cdot (B_H / 2 + 30\text{mm})$ shall be considered. The same applies when the header has joist hanger connections on both sides, but with vertical forces which differ more than 20%.

It is a condition for a force F_{lat} perpendicular to the vertical symmetry line that the joist hanger is connected to a wood-based header with nails in all holes (full nailing) or in all holes marked for partial nailing.

The joist hangers are intended for use for connections subject to static or quasi static loading.

The zinc-coated hangers are for use in timber structures subject to dry, internal conditions defined by the service classes 1 and 2 of EN 1995-1-1 (Eurocode 5).

The joist hangers can also be used in outdoor timber structures, service class 3, when a corrosion protection in accordance with Eurocode 5, table 4.1 (e.g., a Z350 corrosion protection) is applied, or when stainless steel with similar or better characteristic yield and ultimate strength is employed

The scope of the joist hangers regarding resistance to corrosion shall be defined according to national provisions that apply at the installation site considering environmental conditions.

The provisions made in this European Technical Assessment are based on an assumed intended working life of the joist hangers of 50 years.

The indications given on the working life cannot be interpreted as a guarantee given by the producer or Assessment Body, but are to be regarded only as a means for choosing the right products in relation to the expected economically reasonable working life of the works.

3 Performance of the product and references to the methods used for its assessment

Characteristic	Assessment of characteristic
3.1 Mechanical resistance and stability*) (BWR1)	
Joint Strength - Characteristic load-carrying capacity	See Annex B
Joint Stiffness	No performance assessed
Joint ductility	No performance assessed
Resistance to seismic actions	No performance assessed
Resistance to corrosion and deterioration	See section 3.5
3.2 Safety in case of fire (BWR2)	
Reaction to fire	The joist hangers are made from steel classified as Euroclass A1 in accordance with EN 13501-1 and European Commission Delegated Regulation 2016/364 of 1 July 2015
3.3 General aspects related to the performance of the product	
Identification	The joist hangers have been assessed as having satisfactory durability and serviceability when used in timber structures using the timber species described in Eurocode 5 and subject to the conditions defined by service class 1, 2 and 3
	See Annex A

*) See additional information in section 3.4 – 3.6.

3.4 Methods of verification

See annex B for characteristic load-carrying capacities of the joist hangers.

The characteristic capacities of the joist hangers are determined by calculation assisted by testing as described in the EAD 130186-00-0603. They should be used for designs in accordance with Eurocode 5 or a similar national Timber Code.

The design models allow the use of fasteners described in the table on page 19 in Annex A:

Threaded nails (ringed shank nails) in accordance to EN 14592

In the formulas in Annex B the capacities for threaded nails calculated according to Eurocode 5 are used assuming a thick steel plate when calculating the lateral nail load-carrying-capacity for joist hangers 2,0 mm.

Further, the joist hangers may be fastened to a concrete structure or steel member by bolts with a diameter of 10 mm in holes with a diameter of 11 mm and by bolts with a diameter of 12 mm in holes with a diameter of 13 mm.

No performance has been determined in relation to ductility of a joint under cyclic testing. The contribution to the performance of structures in seismic zones, therefore, has not been assessed.

No performance has been determined in relation to the joint's stiffness properties - to be used for the analysis of the serviceability limit state

3.5 Aspects related to the performance of the product

3.5.1 Corrosion protection in service class 1 and 2.

In accordance with EAD 130186-00-0603 the joist hangers have a zinc coating weight of min Z275. The steel employed is DX51D + Z (min Z275) according to EN 10346:2015 with a minimum yield strength R_e of 290 MPa, a minimum tensile strength R_m of 360 MPa and a minimum ultimate strain A_{80} of 22 %.

3.5.2 Corrosion protection in service class 3

In accordance with EAD 130186-00-0603 and Eurocode 5, the joist hangers can also be used in outdoor timber structures, service class 3, when a corrosion protection in accordance with Eurocode 5, table 4.1 (e.g., a Z350 corrosion protection) is applied, or when stainless steel with similar or better characteristic yield and ultimate strength is employed

3.6 General aspects related to the fitness for use of the product

Joist hanger connections

A joist hanger connection in this ETA are assessed provided:

Header – support conditions

- The header shall be restrained against rotation and be free from wane under the joist hanger.

If the header carries joists only on one side, the eccentricity moment from the joists $M_{ec} = R_{joist} (b_{header}/2 + e_{nail})$ shall be considered at the strength verification of the header.

R_{joist} Reaction force from the joists,

b_{header} Width of header,

e_{nail} Distance from nails in the joist to the surface of the header.

- For a header with joists from both sides but with different reaction forces a similar consideration applies.

Wood to wood connections

- Joist hangers may be fastened to wood-based members by nails.
- There shall be nails in all holes or a partial nailing pattern as prescribed in Annex B-C may be used.
- The characteristic capacity of the joist hanger connection is calculated according to the manufacturer's technical documentation, dated 2011-05-20.
- The joist hanger connection is designed in accordance with Eurocode 5 or an appropriate national code.
- The gap between the end of the joist and the surface, where contact stresses can occur during loading shall be limited. This means that for joist hangers with outward flaps the gap between the surface of the end of the joist and that of the header shall be maximum 3 mm.

Joist hangers with inward flaps the gap between the surface of the nail heads in the inward flaps and the end of the joist shall be maximum 8 mm.

- For ESSVE joist hangers with overlapping nails in the joist (see figure 8.5 in EN 1995-1-1) the width of the joist shall be at least $l+4d$, where l is the length of the nails and d is the diameter of the nails in the joist. For joist hangers with staggered nails in the joist the width shall be at least the

penetration length of the nails.

- The cross section of the joist at the joist hanger connection shall have sharp edges at the lower side against the bottom plate, i.e. it shall be without wane.
- The cross section of the header shall have a plane surface against the whole joist hanger.
- The width B_J of the joist shall correspond to that of the joist hanger. B_J shall not be smaller than $B-3$ mm, where B is the inner width of the joist hanger.
- The depth of the joist shall be so large that the top of the joist is at least 20 mm above the upper fastener in the joist.
- Nails to be used shall have a diameter, which fit the holes of the joist hangers. Nails shall have a diameter which is not smaller than the diameter of the hole minus 1 mm.

Wood to concrete or steel

The above mentioned rules for wood to wood connections are applicable also for the connection between the joist and the joist hanger.

- The joist hanger shall be in close contact with the concrete or steel over the whole face. There shall be no intermediate layers in between.
- The gap between the end of the joist and the surface, where contact stresses can occur during loading shall be limited. This means that the gap between the surface of the end of the joist and that of the concrete or steel shall not exceed 3 mm.
- The bolt shall have a diameter not less than the hole diameter minus 2 mm.
- The bolts shall be placed symmetrically about the vertical symmetry line. There shall always be bolts in the 2 upper holes.
- The upper bolts shall have washers according to EN ISO 7094.

4 Attestation and verification of constancy of performance (AVCP)

4.1 AVCP system

According to the decision 97/638/EC of the European Commission¹, as amended, the system(s) of assessment and verification of constancy of performance (see Annex V to Regulation (EU) No 305/2011) is 2+.

5 Technical details necessary for the implementation of the AVCP system, as foreseen in the applicable EAD

Technical details necessary for the implementation of the AVCP system are laid down in the control plan deposited at ETA-Danmark prior to CE marking.

Issued in Copenhagen on 2023-04-24 by

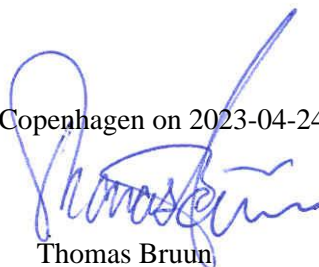

Thomas Bruun
Managing Director, ETA-Danmark

Annex A Product details and definitions

Joist hanger with Blank 238: Face mount hanger with external flanges with and without hook
2,0 mm thick pre-galvanised steel DX51D + Z (min Z275) according to EN 10346 with a minimum R_e of 290 MPa, a minimum tensile strength R_m of 360 MPa and a minimum ultimate strain A_{80} of 22 % with tolerances according to EN 10143:1993.

Table A1:

Blank	Total n° of holes		Width interval		Height interval	
	n_H	n_J	min	max	max	min
238	6	4	40	100	99	69

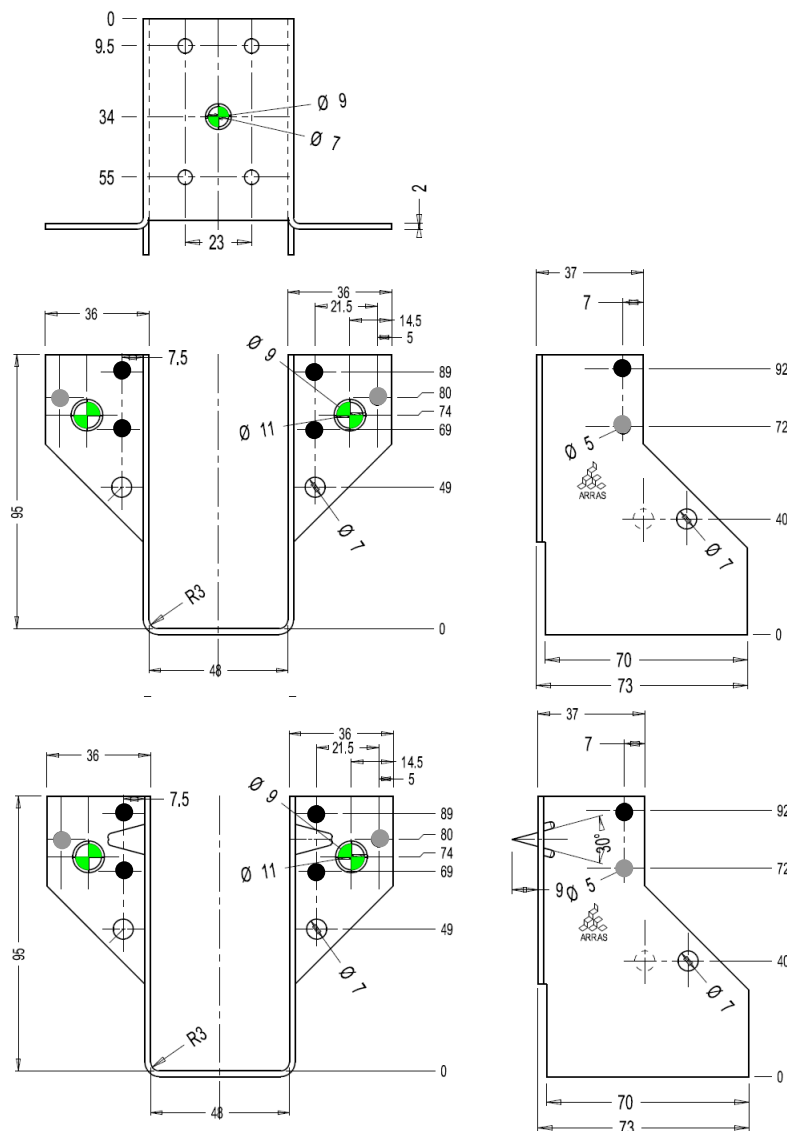

- Partial nailing; Drawing: Blank length 238 mm
 - +● Full nailing; Drawing: Blank length 238 mm
- Joist hanger's height = (blank – width)/2

Joist hanger with Blank 260: Face mount hanger with external flanges with and without hook
 2,0 mm thick pre-galvanised steel DX51D + Z (min Z275) according to EN 10346 with a minimum R_e of 290 MPa, a minimum tensile strength R_m of 360 MPa and a minimum ultimate strain A_{80} of 22 % with tolerances according to EN 10143:1993.

Table A2:

Blank	Total n° of holes		Width interval		Height interval	
	n _H	n _J	min	max	max	min
260	8	4	40	100	110	80

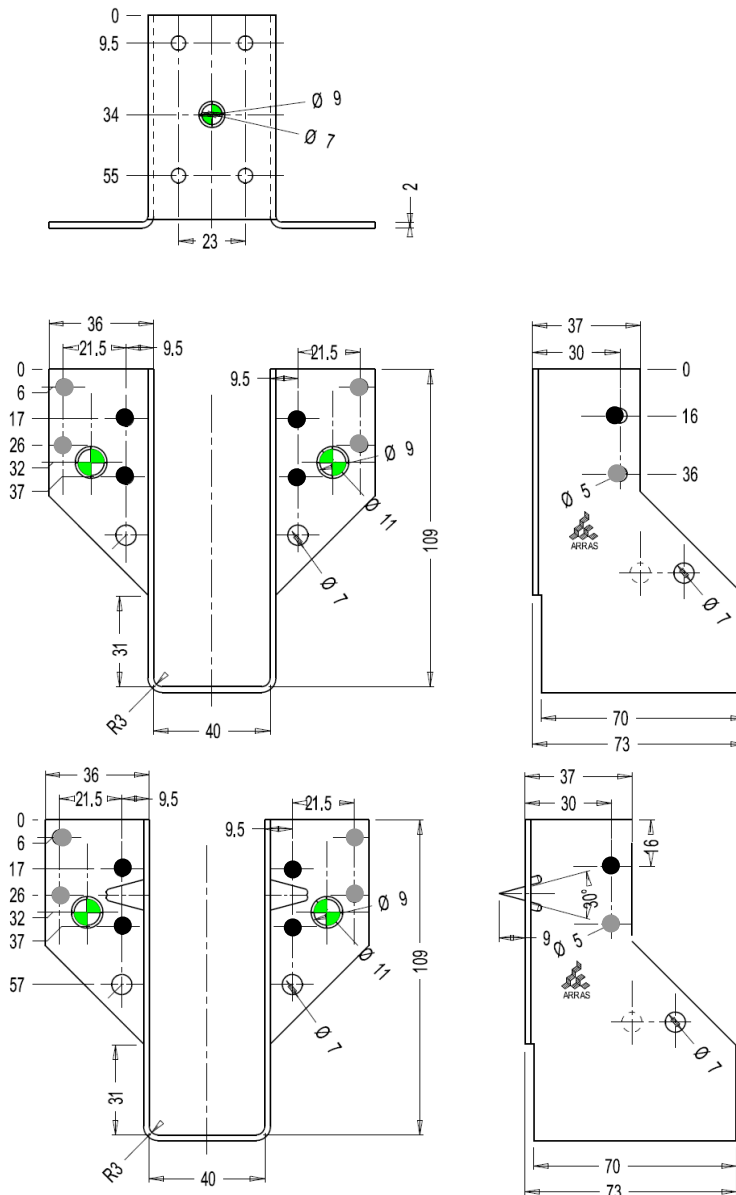

- Partial nailing; Drawing: Blank length 260 mm
 - +● Full nailing; Drawing: Blank length 260 mm
- Joist hanger's height = (blank – width)/2

Joist hanger type with Blank 320: Face mount hanger with external flanges with and without hook
 2,0 mm thick pre-galvanised steel DX51D + Z (min Z275) according to EN 10346 with a minimum R_e of 290 MPa, a minimum tensile strength R_m of 360 MPa and a minimum ultimate strain A_{80} of 22 % with tolerances according to EN 10143:1993.

Table A3:

Blank	Total n° of holes		Width interval		Height interval	
	n_H	n_J	min	max	max	min
320	12	8	40	100	140	110

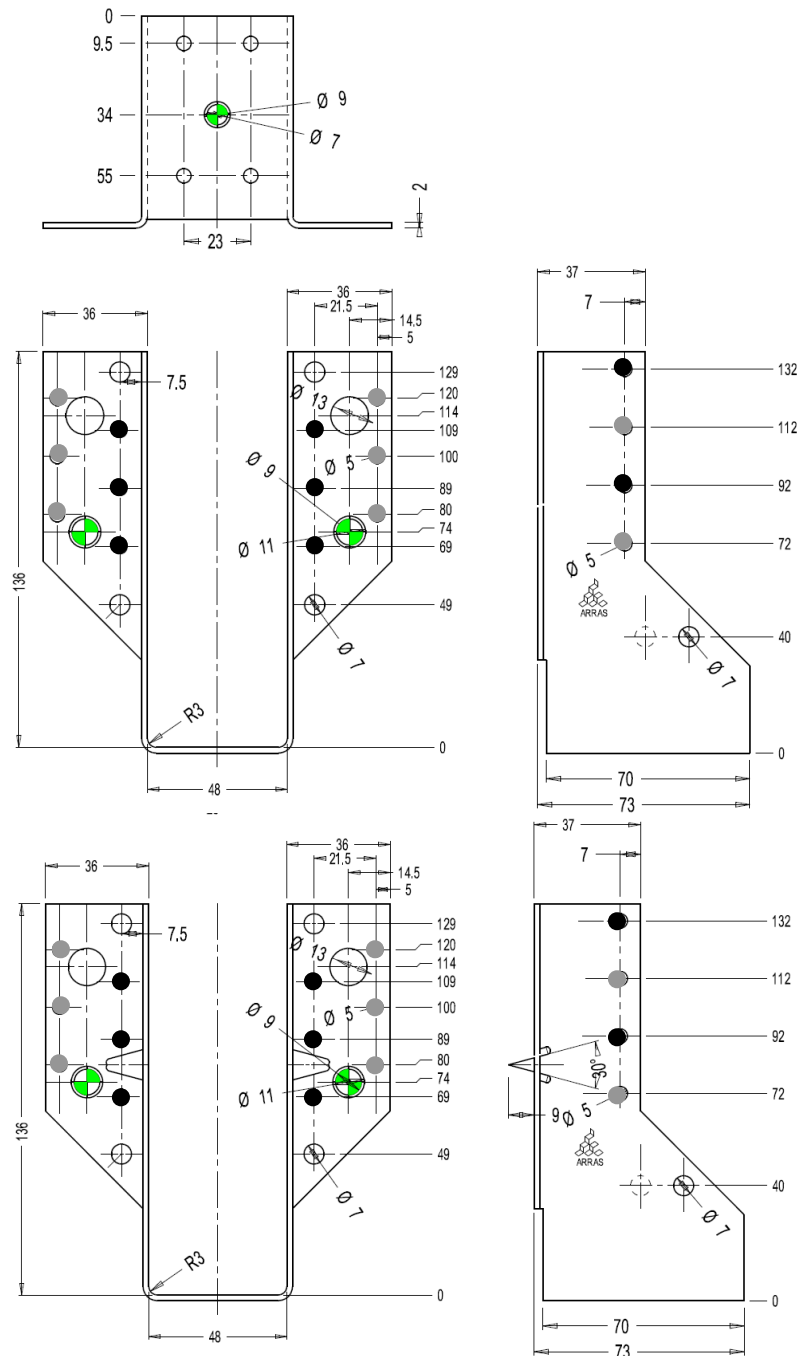

- Partial nailing; Drawing: Blank length 320 mm
 - +● Full nailing; Drawing: Blank length 320 mm
- Joist hanger's height = (blank – width)/2

Joist hanger with Blank 380: Face mount hanger with external flanges with and without hook
 2,0 mm thick pre-galvanised steel DX51D + Z (min Z275) according to EN 10346 with a minimum R_e of 290 MPa, a minimum tensile strength R_m of 360 MPa and a minimum ultimate strain A_{80} of 22 % with tolerances according to EN 10143:1993.

Table A4:

Blank	Total n° of holes		Width interval		Height interval	
	n_H	n_J	min	max	min	max
380	18	10	40	100	170	140

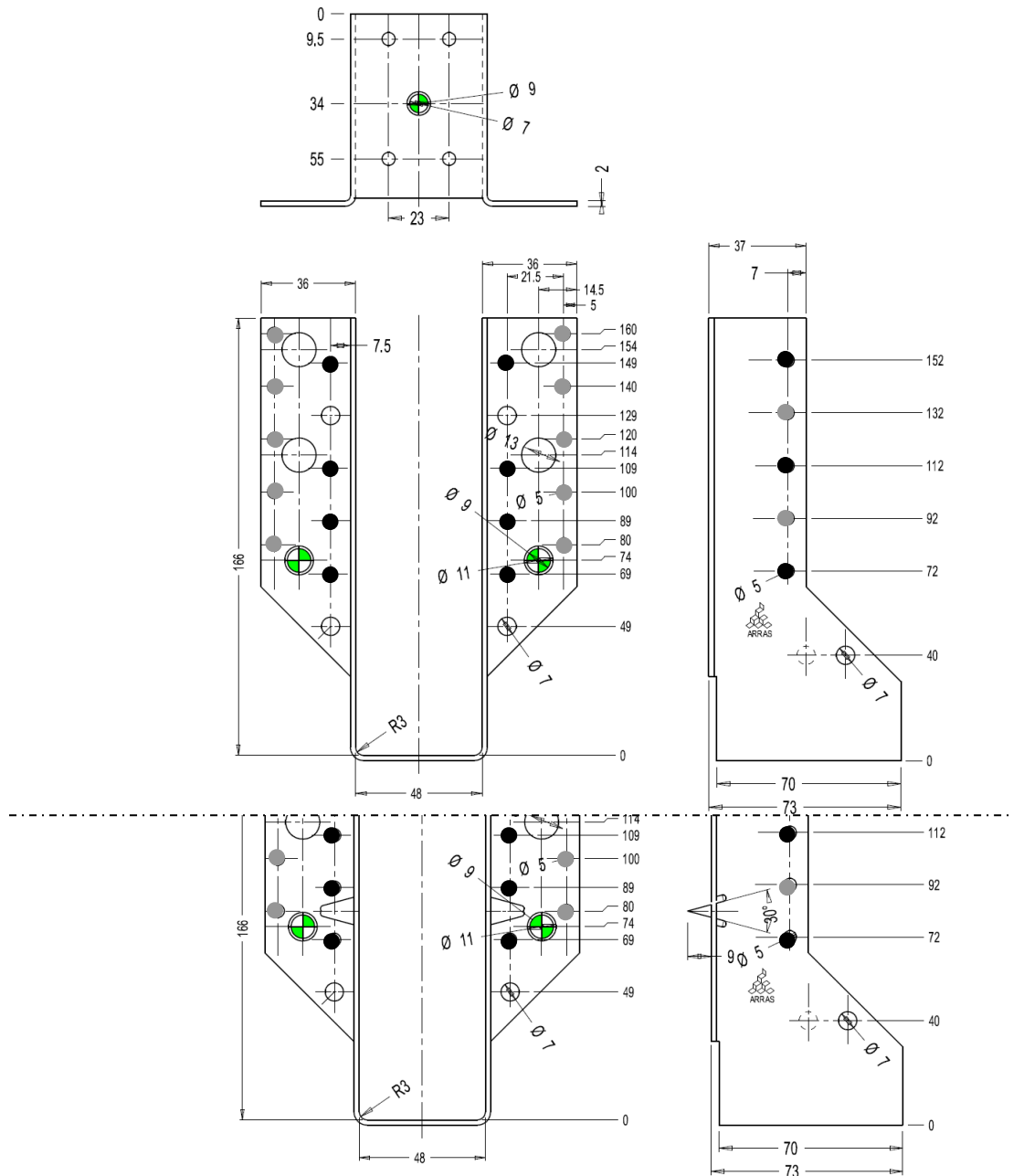

- Partial nailing; Drawing: Blank length 380 mm
 - +● Full nailing; Drawing: Blank length 380 mm
- Joist hanger's height = (blank – width)/2

Joist hanger with blank 440: Face mount hanger with external flanges with and without hook
 2,0 mm thick pre-galvanised steel DX51D + Z (min Z275) according to EN 10346 with a minimum R_e of 290 MPa, a minimum tensile strength R_m of 360 MPa and a minimum ultimate strain A_{80} of 22 % with tolerances according to EN 10143:1993.

Table A5:

Blank	Total n° of holes		Width interval		Height interval	
	n _H	n _J	min	max	min	max
440	24	14	40	100	200	170

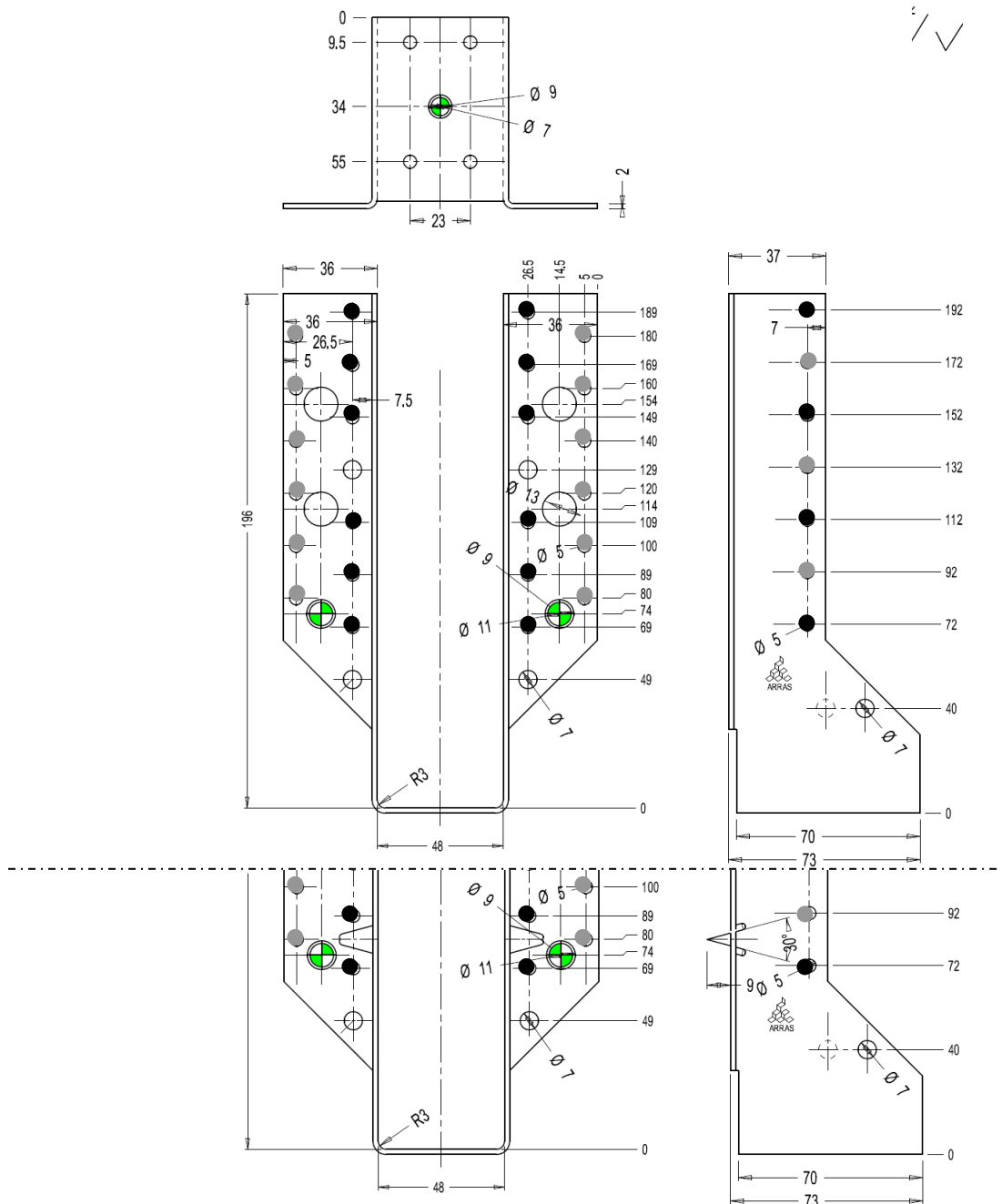

- Partial nailing; Drawing: Blank length 440 mm
 - +● Full nailing; Drawing: Blank length 440 mm
- Joist hanger's height = (blank – width)/2

Joist hanger with blank 500: Face mount hanger with external flanges with and without hook
 2,0 mm thick pre-galvanised steel DX51D + Z (min Z275) according to EN 10346 with a minimum R_e of 290 MPa, a minimum tensile strength R_m of 360 MPa and a minimum ultimate strain A_{80} of 22 % with tolerances according to EN 10143:1993.

Table A6:

Blank	Total n° of holes		Width interval		Height interval	
	n_H	n_J	min	max	min	max
500	28	16	40	100	230	200

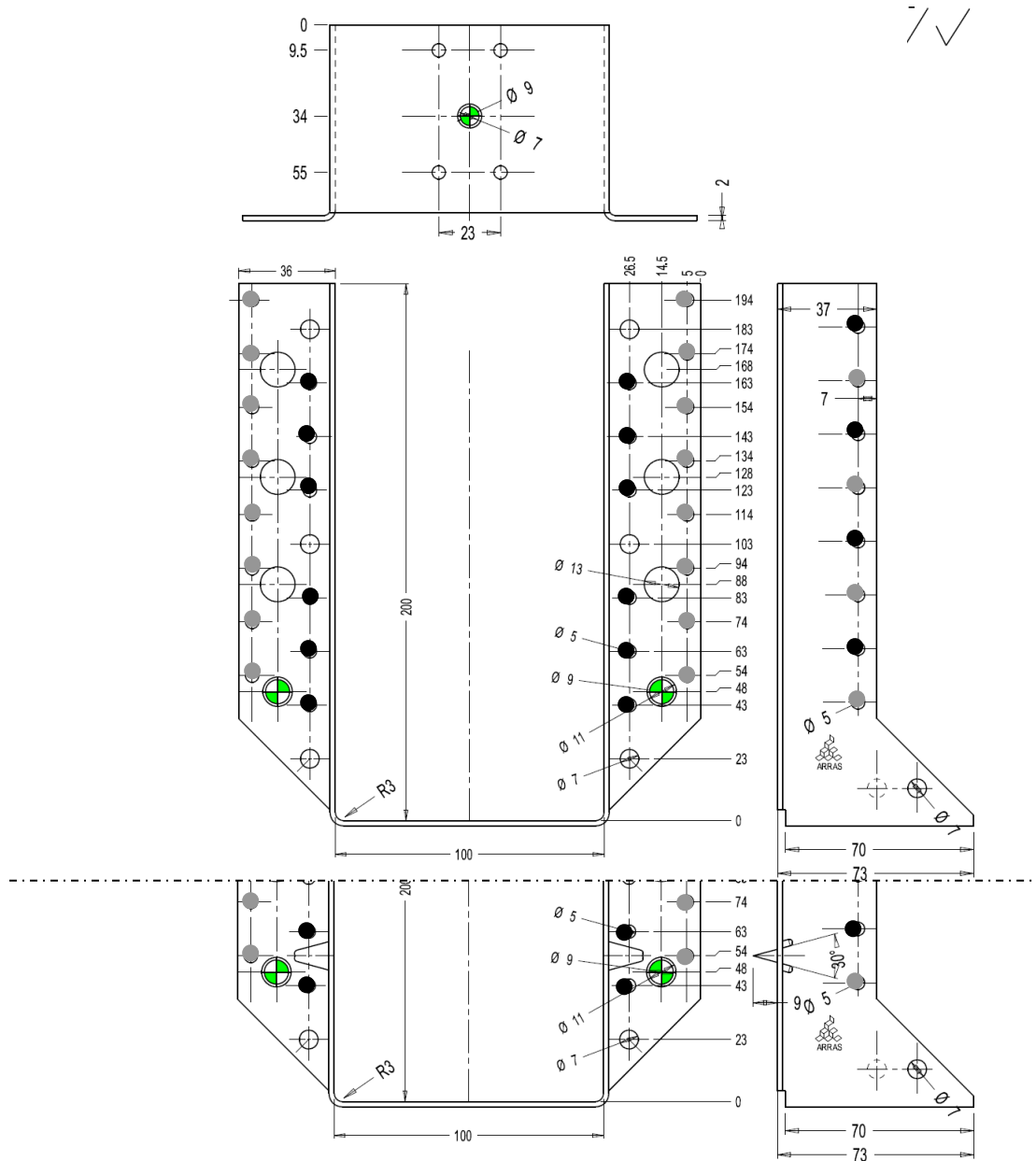

- Partial nailing; Drawing: Blank length 500 mm
 - +● Full nailing; Drawing: Blank length 500 mm
- Joist hanger's height = (blank – width)/2

Joist hanger with Blank 238: Face mount hanger with internal flanges with and without hook
 2,0 mm thick pre-galvanised steel DX51D + Z (min Z275) according to EN 10346 with a minimum R_e of 290 MPa, a minimum tensile strength R_m of 360 MPa and a minimum ultimate strain A_{80} of 22 % with tolerances according to EN 10143:1993.

Table A7:

Blank	Total n° of holes		Width interval		Height interval	
	n _H	n _J	min	max	max	min
238	6	4	40	100	99	69

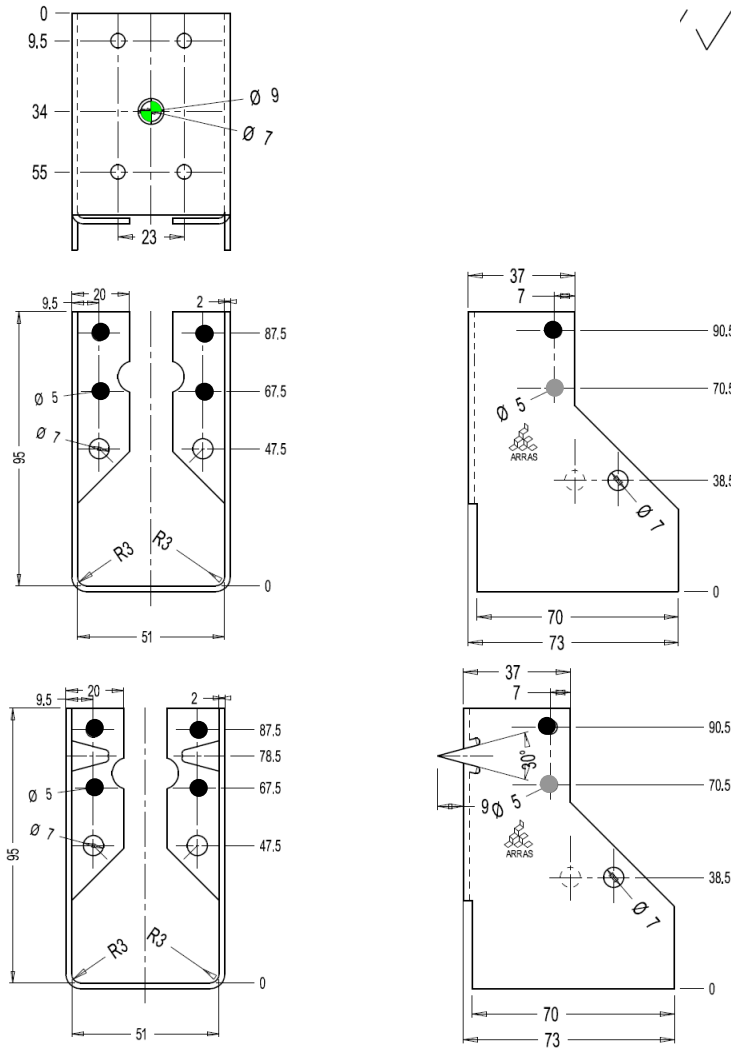

● Partial nailing; Drawing: Blank length 238 mm

●+● Full nailing; Drawing: Blank length 238 mm

Joist hanger's height = (blank – width)/2

Joist hanger with Blank 260: Face mount hanger with internal flanges with and without hook
 2,0 mm thick pre-galvanised steel DX51D + Z (min Z275) according to EN 10346 with a minimum R_e of 290 MPa, a minimum tensile strength R_m of 360 MPa and a minimum ultimate strain A_{80} of 22 % with tolerances according to EN 10143:1993.

Table A8:

Blank	Total n° of holes		Width interval		Height interval	
	n_H	n_J	min	max	max	min
260	8	4	40	100	110	80

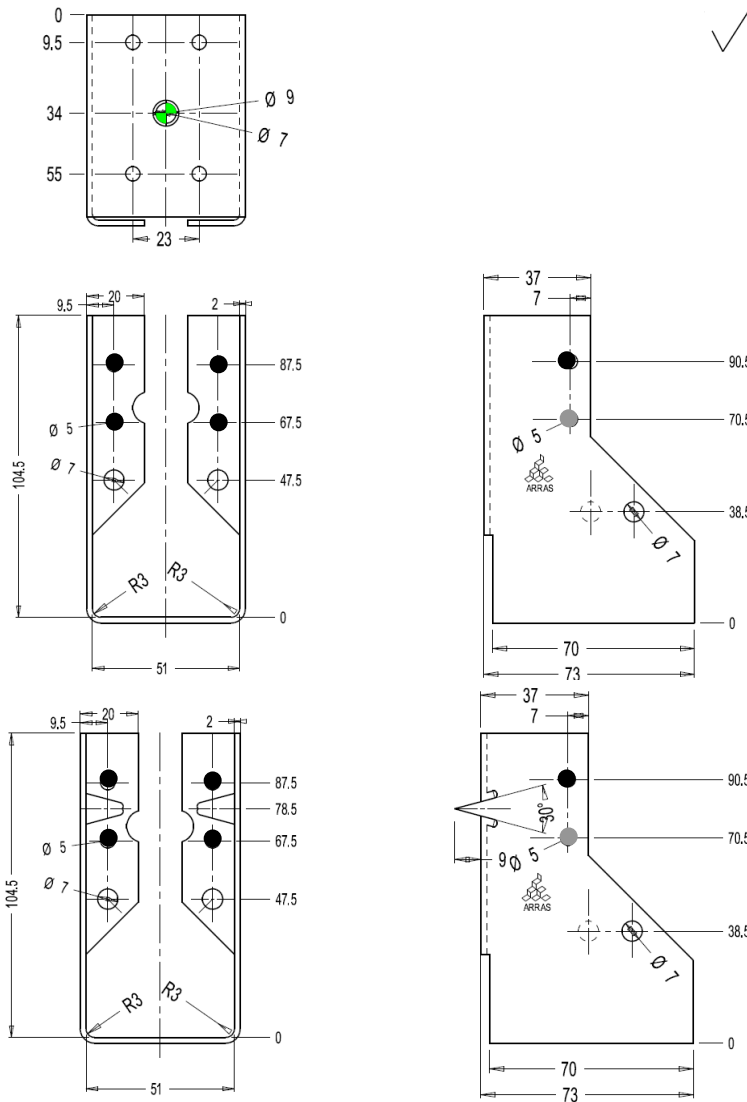

- Partial nailing; Drawing: Blank length 260 mm
 - +● Full nailing; Drawing: Blank length 260 mm
- Joist hanger's height = (blank – width)/2

Joist hanger type with Blank 320: Face mount hanger with internal flanges with and without hook
 2,0 mm thick pre-galvanised steel DX51D + Z (min Z275) according to EN 10346 with a minimum R_e of 290 MPa, a minimum tensile strength R_m of 360 MPa and a minimum ultimate strain A_{80} of 22 % with tolerances according to EN 10143:1993.

Table A9:

Blank	Total n° of hol		Width interval		Height interval	
	n_H	n_J	min	max	max	min
320	12	8	40	100	140	110

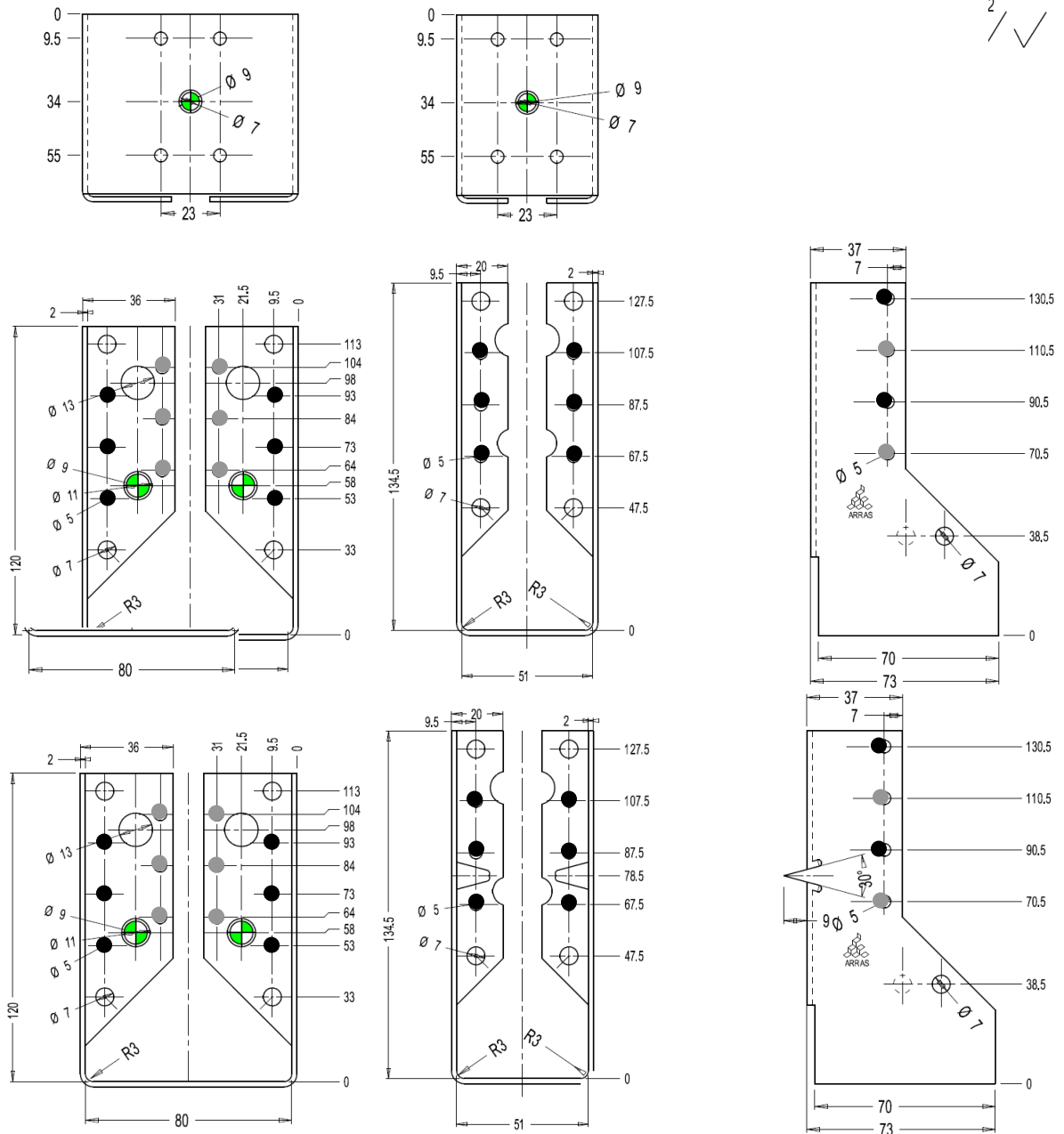

For $B \geq 72$ mm flanges with 2 columns / For $B < 72$ mm flanges with 1 column

● Partial nailing; Drawing: Blank length 320 mm

●+● Full nailing; Drawing: Blank length 320 mm

Joist hanger's height = (blank – width)/2

Joist hanger with Blank 380: Face mount hanger with internal flanges with and without hook
 2,0 mm thick pre-galvanised steel DX51D + Z (min Z275) according to EN 10346 with a minimum R_e of 290 MPa, a minimum tensile strength R_m of 360 MPa and a minimum ultimate strain A_{80} of 22 % with tolerances according to EN 10143:1993.

Table A10:

Blank	Total n° of holes		Width interval		Height interval	
	n _H	n _J	min	max	min	max
380	18	10	40	100	170	140

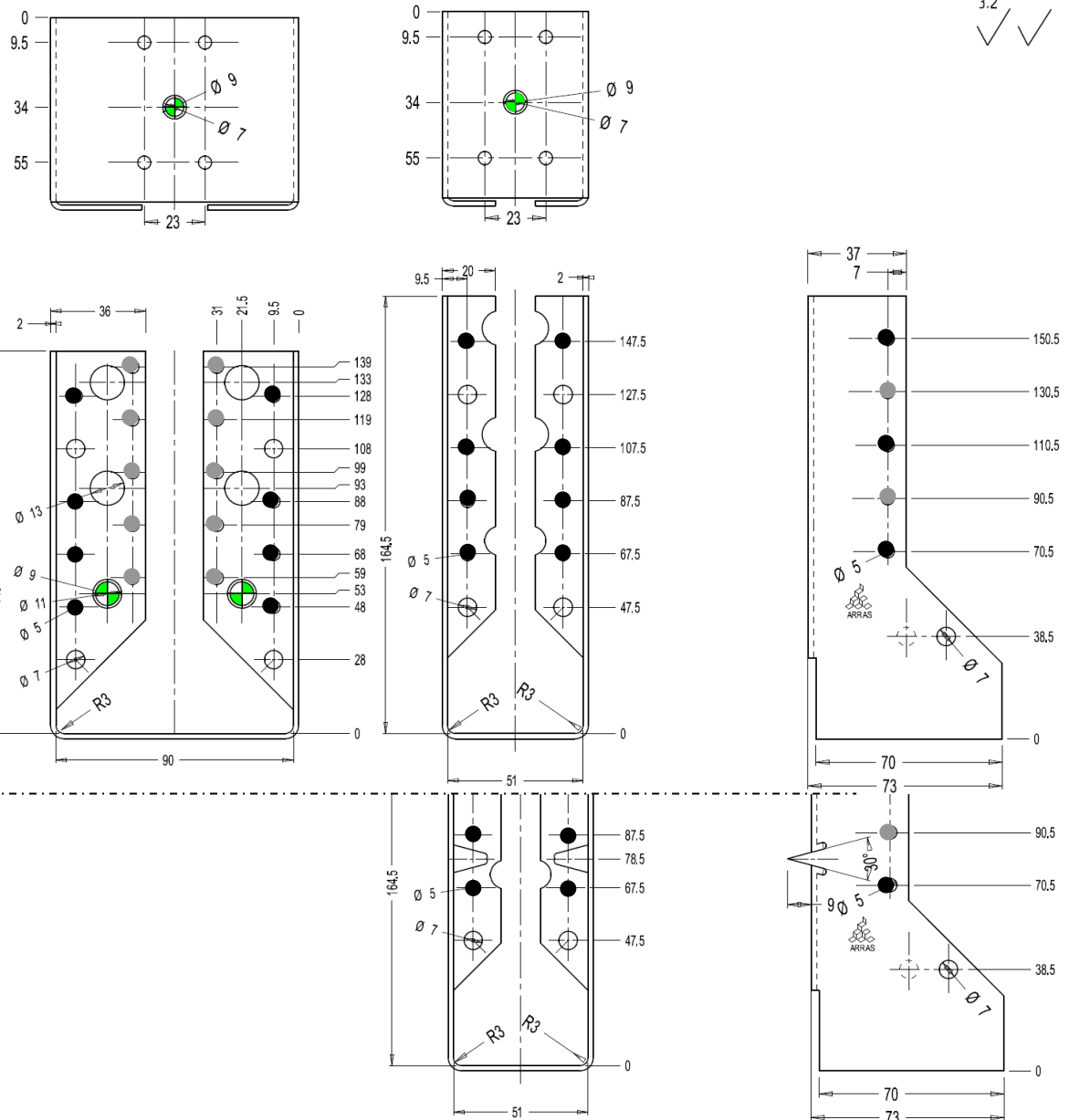

For $B \geq 72$ mm flanges with 2 columns / For $B < 72$ mm flanges with 1 column

- Partial nailing; Drawing: Blank length 380 mm
 - +● Full nailing; Drawing: Blank length 380 mm
- Joist hanger's height = (blank – width)/2

Joist hanger with blank 440: Face mount hanger with internal flanges with and without hook
 2,0 mm thick pre-galvanised steel DX51D + Z (min Z275) according to EN 10346 with a minimum R_e of 290 MPa, a minimum tensile strength R_m of 360 MPa and a minimum ultimate strain A_{80} of 22 % with tolerances according to EN 10143:1993.

Table A11:

Blank	Total n° of holes		Width interval		Height interval	
	n_H	n_J	min	max	min	max
440	24	14	40	100	200	170

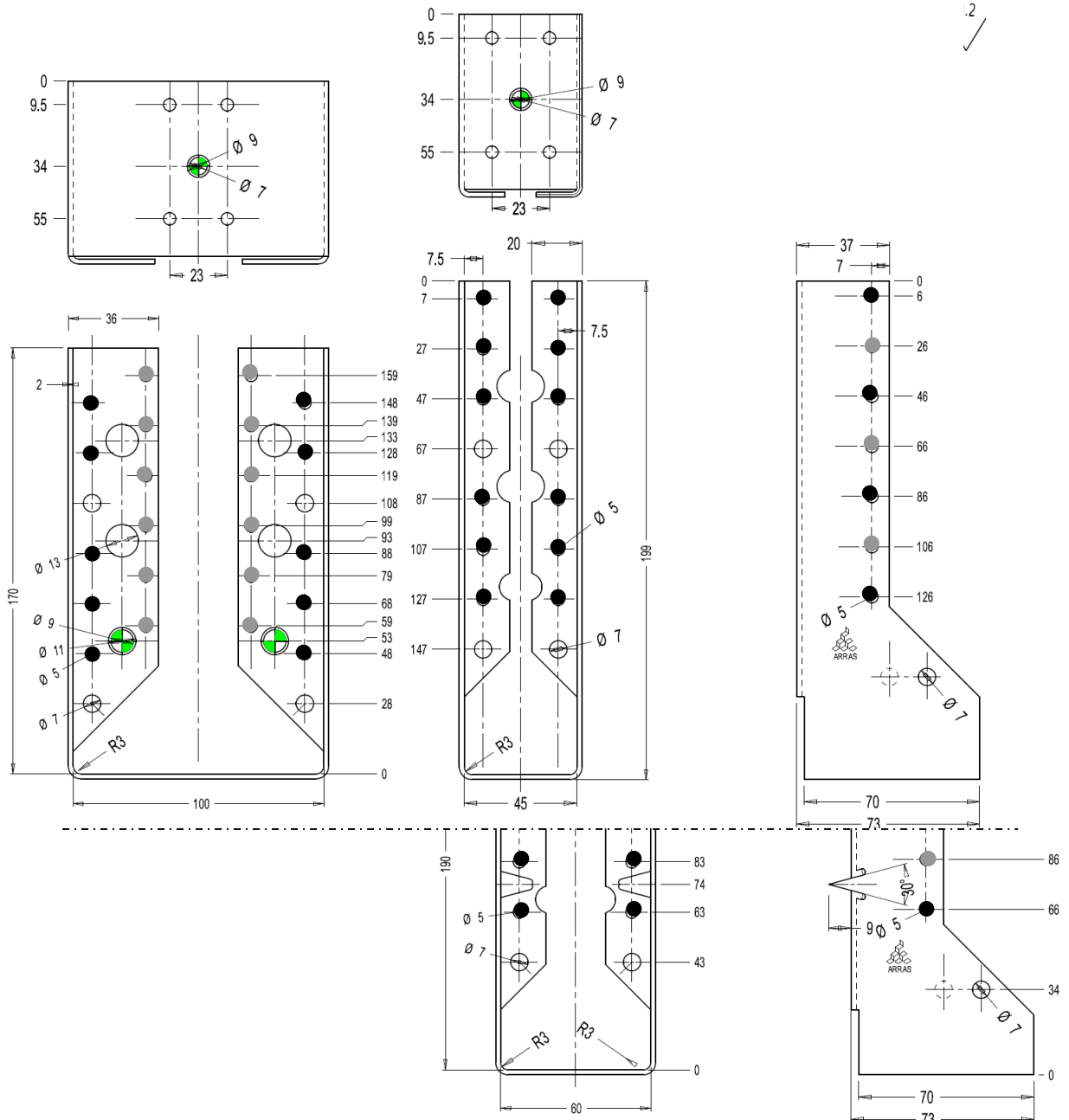

For $B \geq 72$ mm flanges with 2 columns / For $B < 72$ mm flanges with 1 column

- Partial nailing; Drawing: Blank length 440 mm
 - +● Full nailing; Drawing: Blank length 440 mm
- Joist hanger's height = (blank – width)/2

Fastener types and sizes

NAIL diameter	Length Min – max	Nail type
4.0	35 - 100	Ringed shank nails according to EN 14592

BOLT diameter	Corresponding hole diameter	Bolt type
10.0, 12.0	Max. 2 mm. larger than the bolt diameter	See specification of the manufacturer

Annex B Characteristic load-carrying-capacities

Characteristic capacities of the joist hanger connections with nails

The downward and the upward directed forces are assumed to act in the middle of the joist. The lateral force is assumed to act at a distance $e_{J,90}$ above the centre of gravity of the nails in the joist.

Two nail patterns are specified. A full nailing pattern, where there are nails in all the holes, and a partial nailing pattern, where the number of nails in the joist and the header are at least half the numbers specified for full nailing. The nails in the joist may be staggered and there shall always be a nail in the upper and the lower holes. The other nails are distributed evenly over the height. The nails in the header shall be put in the holes closest to the bend line.

For joist hangers with overlapping nails in the joist (see figure 8.5 in EN 1995-1-1) the width of the joist shall be at least $l+4d$, where l is the length of the nails and d is the diameter of the nails in the joist. For joist hangers with staggered nails in the joist the width shall be at least the penetration length of the nails.

B.1 Joist hangers fastened with nails

Force downward toward the bottom plate:

$$F_{Z,Rk} = \min \left\{ \frac{(n_J + 2) \cdot F_{v,J,Rk}}{1}, \sqrt{\left(\frac{1}{n_H \cdot F_{v,H,Rk}} \right)^2 + \left(\frac{1}{k_{H,1} \cdot F_{ax,H,Rk}} \right)^2} \right\} \quad (B.1.1)$$

Force upward away from the bottom plate:

$$F_{Z,Rk} = \min \left\{ \frac{n_J \cdot F_{v,J,Rk}}{1}, \sqrt{\left(\frac{1}{n_H \cdot F_{v,H,Rk}} \right)^2 + \left(\frac{1}{k_{H,2} \cdot F_{ax,H,Rk}} \right)^2} \right\} \quad (B.1.2)$$

Lateral force

$$F_{Y,Rk} = \min \left\{ \frac{n_J \cdot F_{v,J,Rk}}{\sqrt{\left(\frac{2 \cdot \sqrt{e_{J,0}^2 + e_{J,90}^2}}{B} \right)^2 + \left(\frac{F_{v,J,Rk}}{F_{ax,J,Rk}} \right)^2}}, \frac{F_{v,H,Rk}}{\sqrt{\left(\frac{1}{n_H} + \frac{e_H}{e_1} \right)^2 + \left(\frac{e_H}{e_2} \right)^2}} \right\} \quad (B.1.3)$$

n_J total number of nails in both sides of the joist

n_H total number of nails in the side of the header

$F_{v,Rk}$ characteristic lateral load-carrying capacity of a nail in the joist or in the header indicated by the indices J or H in N, for 2,0 mm or 2,5 mm steel plates, the Eurocode 5 equations for thick steel plates may be applied

$F_{ax,Rk}$ characteristic axial load-carrying capacity of a nail in the joist or in the header indicated by the indices J or H in N

B width of the joist hanger in mm, see figure B1

$e_{J,90}$ distance of the lateral force above the centre of gravity of the nails in the joist in mm, see Tables B1 to B12. $e_{J,90}$ must not be taken less than 0,2 times the depth of the joist hanger

$e_{J,0}$ joist hanger dimension in mm, see Tables B1 to B12

- e_H distance of the lateral force above the centre of gravity of the nails in the header.
- e_1 joist hanger dimension in mm, see Tables B1 to B12
- e_2 joist hanger dimension in mm, see Tables B1 to B12
- $k_{H,1}$ form factor, see Tables B1 to B12
- $k_{H,2}$ form factor, see Tables B1 to B12

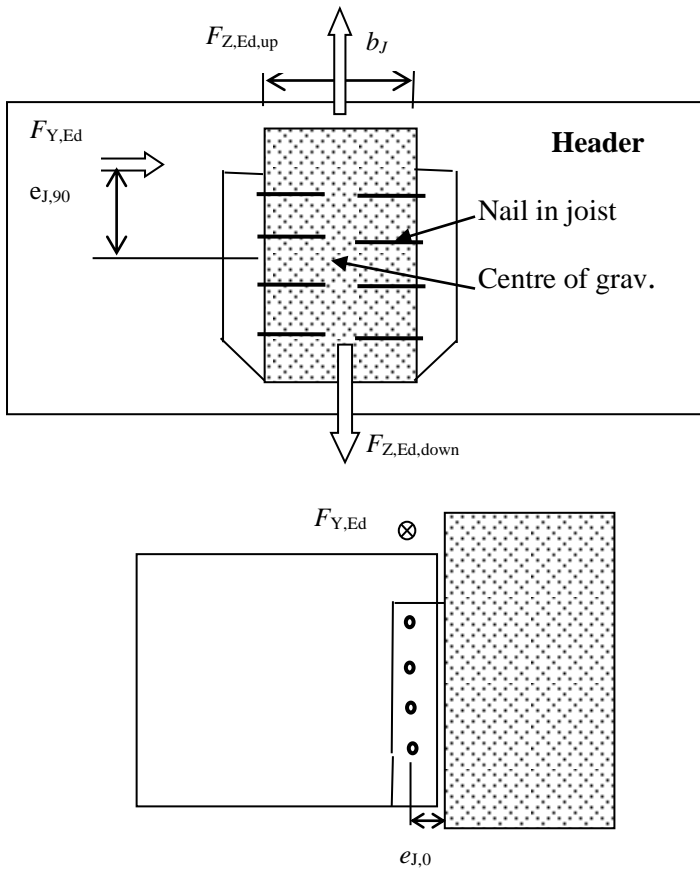

Figure B1: Definition of $e_{J,90}$ and $e_{J,0}$

Combined forces

In case of combined forces the relevant of the following inequalities shall be fulfilled:

Downward force:
$$\left(\frac{F_{Down,Ed}}{F_{Down,Rk}} \right)^2 + \left(\frac{F_{lat,Ed}}{F_{lat,Rk}} \right)^2 \leq 1,0 \quad (B.1.4)$$

Upward force:
$$\left(\frac{F_{Up,Ed}}{F_{Up,Rk}} \right)^2 + \left(\frac{F_{lat,Ed}}{F_{lat,Rk}} \right)^2 \leq 1,0 \quad (B.1.5)$$

Table B1: Joist hanger Blank 238 with external flanges: Form factors $k_{H,1}$ and $k_{H,2}$ and dimensions e_1 and e_2 ; $e_{J,0} = 30$ mm

B [mm]	H [mm]	full nailing						partial nailing					
		n_H	n_J	$k_{H,1}$	$k_{H,2}$	e_1 [mm]	e_2 [mm]	n_H	n_J	$k_{H,1}$	$k_{H,2}$	e_1 [mm]	e_2 [mm]
40	99	6	4	13,1	1,60	908	178	4	2	8,72	1,33	388	132
42	98	6	4	12,9	1,60	953	183	4	2	8,59	1,33	412	135
44	97	6	4	12,7	1,60	999	188	4	2	8,46	1,33	437	139
45	97	6	4	12,6	1,60	1022	191	4	2	8,40	1,33	450	141
46	96	6	4	12,5	1,60	1046	194	4	2	8,33	1,33	463	142
48	95	6	4	12,3	1,60	1094	199	4	2	8,20	1,33	489	146
50	94	6	4	12,1	1,60	1143	204	4	2	8,08	1,33	516	150
51	94	6	4	12,0	1,60	1169	207	4	2	8,01	1,33	530	151
52	93	6	4	11,9	1,60	1194	209	4	2	7,95	1,33	544	153
54	92	6	4	11,8	1,60	1246	215	4	2	7,82	1,33	573	157
56	91	6	4	11,6	1,60	1299	220	4	2	7,69	1,33	603	161
58	90	6	4	11,4	1,60	1353	226	4	2	7,56	1,33	633	164
60	89	6	4	11,2	1,60	1408	231	4	2	7,43	1,33	664	168
62	88	6	4	11,0	1,60	1465	236	4	2	7,30	1,33	696	172
64	87	6	4	10,8	1,60	1523	242	4	2	7,18	1,33	729	176
66	86	6	4	10,6	1,60	1582	247	4	2	7,05	1,33	763	179
68	85	6	4	10,4	1,60	1642	253	4	2	6,92	1,33	797	183
70	84	6	4	10,2	1,60	1703	258	4	2	6,79	1,33	832	187
72	83	6	4	10,0	1,60	1766	264	4	2	6,66	1,33	868	191
73	83	6	4	9,92	1,60	1798	266	4	2	6,60	1,33	886	193
74	82	6	4	9,82	1,60	1830	269	4	2	6,54	1,33	905	195
76	81	6	4	9,63	1,60	1895	275	4	2	6,41	1,33	943	198
78	80	6	4	9,43	1,60	1961	280	4	2	6,28	1,33	981	202
80	79	6	4	9,24	1,60	2028	286	4	2	6,16	1,33	1020	206
82	78	6	4	9,05	1,60	2097	291	4	2	6,03	1,33	1060	210
84	77	6	4	8,86	1,60	2167	297	4	2	5,90	1,33	1101	214
86	76	6	4	8,67	1,60	2238	302	4	2	5,78	1,33	1143	218
88	75	6	4	8,48	1,60	2310	308	4	2	5,65	1,33	1185	221
90	74	6	4	8,29	1,60	2383	314	4	2	5,53	1,33	1228	225
92	73	6	4	8,10	1,60	2458	319	4	2	5,40	1,33	1272	229
94	72	6	4	7,91	1,60	2534	325	4	2	5,28	1,33	1317	233
96	71	6	4	7,72	1,60	2611	330	4	2	5,15	1,33	1363	237
98	70	6	4	7,53	1,60	2689	336	4	2	5,03	1,33	1409	241
100	69	6	4	7,34	1,60	2768	342	4	2	4,90	1,33	1456	245

Table B2: Joist hanger Blank 260 with external flanges: Form factors $k_{H,1}$ and $k_{H,2}$ and dimensions e_1 and e_2 ; $e_{J,0} = 30$ mm

B [mm]	H [mm]	full nailing						partial nailing					
		n_H	n_J	$k_{H,1}$	$k_{H,2}$	e_1 [mm]	e_2 [mm]	n_H	n_J	$k_{H,1}$	$k_{H,2}$	e_1 [mm]	e_2 [mm]
40	110	8	4	17,9	3,19	963	293	4	2	8,72	1,33	388	132
42	109	8	4	17,6	3,19	1005	300	4	2	8,59	1,33	412	135
44	108	8	4	17,3	3,19	1048	307	4	2	8,46	1,33	437	139
45	108	8	4	17,2	3,19	1070	310	4	2	8,40	1,33	450	141
46	107	8	4	17,1	3,19	1092	314	4	2	8,33	1,33	463	142
48	106	8	4	16,8	3,19	1137	321	4	2	8,20	1,33	489	146
50	105	8	4	16,6	3,19	1184	328	4	2	8,08	1,33	516	150
51	105	8	4	16,4	3,19	1207	331	4	2	8,01	1,33	530	151
52	104	8	4	16,3	3,19	1231	335	4	2	7,95	1,33	544	153
54	103	8	4	16,1	3,19	1279	342	4	2	7,82	1,33	573	157
56	102	8	4	15,8	3,19	1328	349	4	2	7,69	1,33	603	161

B [mm]	H [mm]	full nailing						partial nailing					
		n _H	n _J	k _{H,1}	k _{H,2}	e ₁ [mm]	e ₂ [mm]	n _H	n _J	k _{H,1}	k _{H,2}	e ₁ [mm]	e ₂ [mm]
58	101	8	4	15,6	3,19	1379	356	4	2	7,56	1,33	633	164
60	100	8	4	15,3	3,19	1430	363	4	2	7,43	1,33	664	168
62	99	8	4	15,1	3,19	1483	371	4	2	7,30	1,33	696	172
64	98	8	4	14,8	3,19	1536	378	4	2	7,18	1,33	729	176
66	97	8	4	14,6	3,19	1590	385	4	2	7,05	1,33	763	179
68	96	8	4	14,3	3,19	1646	392	4	2	6,92	1,33	797	183
70	95	8	4	14,1	3,19	1702	400	4	2	6,79	1,33	832	187
72	94	8	4	13,8	3,19	1760	407	4	2	6,66	1,33	868	191
73	94	8	4	13,7	3,19	1789	411	4	2	6,60	1,33	886	193
74	93	8	4	13,5	3,19	1819	415	4	2	6,54	1,33	905	195
76	92	8	4	13,3	3,19	1878	422	4	2	6,41	1,33	943	198
78	91	8	4	13,1	3,19	1939	429	4	2	6,28	1,33	981	202
80	90	8	4	12,8	3,19	2000	437	4	2	6,16	1,33	1020	206
82	89	8	4	12,6	3,19	2063	444	4	2	6,03	1,33	1060	210
84	88	8	4	12,3	3,19	2127	452	4	2	5,90	1,33	1101	214
86	87	8	4	12,1	3,19	2192	459	4	2	5,78	1,33	1143	218
88	86	8	4	11,8	3,19	2257	467	4	2	5,65	1,33	1185	221
90	85	8	4	11,6	3,19	2324	474	4	2	5,53	1,33	1228	225
92	84	8	4	11,3	3,19	2392	482	4	2	5,40	1,33	1272	229
94	83	8	4	11,1	3,19	2461	489	4	2	5,28	1,33	1317	233
96	82	8	4	10,8	3,19	2531	497	4	2	5,15	1,33	1363	237
98	81	8	4	10,6	3,19	2602	504	4	2	5,03	1,33	1409	241
100	80	8	4	10,3	3,19	2674	512	4	2	4,90	1,33	1456	245

Table B3: Joist hanger Blank 320 with external flanges: Form factors k_{H,1} and k_{H,2} and dimensions e₁ and e₂; e_{1,0} = 30 mm

B [mm]	H [mm]	full nailing						partial nailing					
		n _H	n _J	k _{H,1}	k _{H,2}	e ₁ [mm]	e ₂ [mm]	n _H	n _J	k _{H,1}	k _{H,2}	e ₁ [mm]	e ₂ [mm]
40	140	12	8	28,5	7,43	956	478	6	4	13,9	3,33	341	231
42	139	12	8	28,2	7,43	995	488	6	4	13,7	3,33	359	235
44	138	12	8	27,8	7,43	1034	498	6	4	13,5	3,33	378	240
45	138	12	8	27,6	7,43	1054	502	6	4	13,4	3,33	387	242
46	137	12	8	27,4	7,43	1074	507	6	4	13,3	3,33	397	244
48	136	12	8	27,0	7,43	1116	517	6	4	13,1	3,33	417	249
50	135	12	8	26,7	7,43	1158	527	6	4	13,0	3,33	437	253
51	135	12	8	26,5	7,43	1179	532	6	4	12,9	3,33	448	256
52	134	12	8	26,3	7,43	1201	537	6	4	12,8	3,33	458	258
54	133	12	8	25,9	7,43	1245	547	6	4	12,6	3,33	480	263
56	132	12	8	25,6	7,43	1290	557	6	4	12,4	3,33	502	268
58	131	12	8	25,2	7,43	1336	568	6	4	12,2	3,33	525	273
60	130	12	8	24,8	7,43	1382	578	6	4	12,0	3,33	548	278
62	129	12	8	24,5	7,43	1430	588	6	4	11,8	3,33	572	283
64	128	12	8	24,1	7,43	1479	599	6	4	11,7	3,33	597	288
66	127	12	8	23,8	7,43	1528	609	6	4	11,5	3,33	622	293
68	126	12	8	23,4	7,43	1579	619	6	4	11,3	3,33	648	298
70	125	12	8	23,0	7,43	1631	630	6	4	11,1	3,33	674	303
72	124	12	8	22,7	7,43	1683	641	6	4	10,9	3,33	701	308
73	124	12	8	22,5	7,43	1710	646	6	4	10,8	3,33	715	311
74	123	12	8	22,3	7,43	1736	651	6	4	10,8	3,33	729	313
76	122	12	8	21,9	7,43	1791	662	6	4	10,6	3,33	757	319
78	121	12	8	21,6	7,43	1846	673	6	4	10,4	3,33	786	324
80	120	12	8	21,2	7,43	1902	683	6	4	10,2	3,33	815	329
82	119	12	8	20,9	7,43	1960	694	6	4	10,0	3,33	845	335

B [mm]	H [mm]	full nailing						partial nailing					
		n _H	n _J	k _{H,1}	k _{H,2}	e ₁ [mm]	e ₂ [mm]	n _H	n _J	k _{H,1}	k _{H,2}	e ₁ [mm]	e ₂ [mm]
84	118	12	8	20,5	7,43	2018	705	6	4	9,85	3,33	876	340
86	117	12	8	20,2	7,43	2077	716	6	4	9,67	3,33	907	345
88	116	12	8	19,8	7,43	2137	726	6	4	9,49	3,33	939	351
90	115	12	8	19,5	7,43	2198	737	6	4	9,31	3,33	971	356
92	114	12	8	19,1	7,43	2260	748	6	4	9,13	3,33	1004	362
94	113	12	8	18,8	7,43	2322	759	6	4	8,95	3,33	1038	367
96	112	12	8	18,4	7,43	2386	770	6	4	8,78	3,33	1072	373
98	111	12	8	18,1	7,43	2451	781	6	4	8,60	3,33	1107	378
100	110	12	8	17,7	7,43	2516	792	6	4	8,43	3,33	1142	384

Table B4: Joist hanger Blank 380 with external flanges: Form factors k_{H,1} and k_{H,2} and dimensions e₁ and e₂; e_{1,0} = 30 mm

B [mm]	H [mm]	full nailing						partial nailing					
		n _H	n _J	k _{H,1}	k _{H,2}	e ₁ [mm]	e ₂ [mm]	n _H	n _J	k _{H,1}	k _{H,2}	e ₁ [mm]	e ₂ [mm]
40	170	18	10	45,6	33,2	1507	1345	8	5	19,5	9,67	349	473
42	169	18	10	45,2	33,0	1532	1340	8	5	19,3	9,67	361	474
44	168	18	10	44,7	32,8	1557	1337	8	5	19,1	9,67	373	474
45	168	18	10	44,5	32,7	1570	1335	8	5	19,0	9,67	380	475
46	167	18	10	44,2	32,6	1584	1334	8	5	18,9	9,67	386	475
48	166	18	10	43,8	32,3	1611	1332	8	5	18,6	9,67	399	477
50	165	18	10	43,3	32,1	1639	1331	8	5	18,4	9,67	413	479
51	165	18	10	43,1	32,0	1653	1331	8	5	18,3	9,67	420	480
52	164	18	10	42,8	31,9	1668	1331	8	5	18,2	9,67	427	481
54	163	18	10	42,3	31,7	1697	1332	8	5	18,0	9,67	441	484
56	162	18	10	41,9	31,5	1728	1333	8	5	17,7	9,67	456	487
58	161	18	10	41,4	31,3	1760	1334	8	5	17,5	9,67	471	490
60	160	18	10	41,0	31,0	1792	1337	8	5	17,3	9,67	487	493
62	159	18	10	40,5	30,8	1825	1339	8	5	17,1	9,67	503	497
64	158	18	10	40,0	30,6	1859	1343	8	5	16,8	9,67	519	501
66	157	18	10	39,6	30,4	1894	1347	8	5	16,6	9,67	536	505
68	156	18	10	39,1	30,2	1930	1351	8	5	16,4	9,67	553	509
70	155	18	10	38,6	30,0	1967	1356	8	5	16,2	9,67	571	513
72	154	18	10	38,2	29,8	2004	1361	8	5	16,0	9,67	589	518
73	154	18	10	38,0	29,7	2024	1364	8	5	15,8	9,67	598	520
74	153	18	10	37,7	29,6	2043	1367	8	5	15,7	9,67	607	523
76	152	18	10	37,3	29,4	2082	1373	8	5	15,5	9,67	626	527
78	151	18	10	36,8	29,2	2122	1380	8	5	15,3	9,67	645	532
80	150	18	10	36,4	29,0	2163	1386	8	5	15,1	9,67	665	537
82	149	18	10	35,9	28,8	2205	1394	8	5	14,9	9,67	685	543
84	148	18	10	35,5	28,6	2248	1401	8	5	14,7	9,67	705	548
86	147	18	10	35,0	28,4	2292	1409	8	5	14,4	9,67	726	553
88	146	18	10	34,6	28,2	2336	1417	8	5	14,2	9,67	747	559
90	145	18	10	34,1	28,0	2382	1426	8	5	14,0	9,67	769	564
92	144	18	10	33,7	27,9	2428	1435	8	5	13,8	9,67	791	570
94	143	18	10	33,2	27,7	2475	1444	8	5	13,6	9,67	813	576
96	142	18	10	32,8	27,5	2523	1453	8	5	13,4	9,67	836	582
98	141	18	10	32,3	27,3	2572	1463	8	5	13,2	9,67	859	588
100	140	18	10	31,9	27,1	2622	1473	8	5	13,0	9,67	883	594

Table B5: Joist hanger Blank 440 with external flanges: Form factors $k_{H,1}$ and $k_{H,2}$ and dimensions e_1 and e_2 ; $e_{1,0} = 30$ mm

B [mm]	H [mm]	full nailing						partial nailing					
		n_H	n_J	$k_{H,1}$	$k_{H,2}$	e_1 [mm]	e_2 [mm]	n_H	n_J	$k_{H,1}$	$k_{H,2}$	e_1 [mm]	e_2 [mm]
40	200	24	14	71,3	45,7	1713	2015	12	8	37,1	18,2	547	1113
42	199	24	14	70,7	45,5	1737	2005	12	8	36,8	18,2	559	1100
44	198	24	14	70,0	45,3	1763	1996	12	8	36,5	18,2	572	1089
45	198	24	14	69,7	45,2	1776	1992	12	8	36,3	18,2	578	1084
46	197	24	14	69,4	45,1	1790	1988	12	8	36,1	18,2	585	1079
48	196	24	14	68,8	44,9	1817	1982	12	8	35,8	18,2	598	1071
50	195	24	14	68,1	44,7	1845	1977	12	8	35,5	18,2	611	1063
51	195	24	14	67,8	44,6	1860	1975	12	8	35,3	18,2	618	1060
52	194	24	14	67,5	44,5	1874	1973	12	8	35,2	18,2	625	1057
54	193	24	14	66,9	44,3	1904	1970	12	8	34,8	18,2	640	1052
56	192	24	14	66,3	44,1	1935	1968	12	8	34,5	18,2	655	1047
58	191	24	14	65,6	43,9	1967	1967	12	8	34,2	18,2	670	1044
60	190	24	14	65,0	43,7	1999	1967	12	8	33,8	18,2	685	1041
62	189	24	14	64,4	43,5	2033	1967	12	8	33,5	18,2	701	1039
64	188	24	14	63,8	43,4	2067	1969	12	8	33,2	18,2	718	1038
66	187	24	14	63,1	43,2	2102	1971	12	8	32,9	18,2	735	1037
68	186	24	14	62,5	43,0	2138	1974	12	8	32,5	18,2	752	1037
70	185	24	14	61,9	42,8	2175	1977	12	8	32,2	18,2	769	1037
72	184	24	14	61,3	42,6	2213	1982	12	8	31,9	18,2	787	1038
73	184	24	14	61,0	42,5	2232	1984	12	8	31,7	18,2	797	1039
74	183	24	14	60,7	42,4	2251	1987	12	8	31,6	18,2	806	1040
76	182	24	14	60,1	42,2	2291	1992	12	8	31,3	18,2	825	1042
78	181	24	14	59,4	42,1	2331	1998	12	8	30,9	18,2	844	1044
80	180	24	14	58,8	41,9	2372	2005	12	8	30,6	18,2	863	1047
82	179	24	14	58,2	41,7	2414	2012	12	8	30,3	18,2	883	1050
84	178	24	14	57,6	41,5	2457	2020	12	8	30,0	18,2	904	1053
86	177	24	14	57,0	41,3	2501	2028	12	8	29,7	18,2	925	1057
88	176	24	14	56,4	41,2	2546	2036	12	8	29,4	18,2	946	1061
90	175	24	14	55,8	41,0	2591	2046	12	8	29,0	18,2	967	1065
92	174	24	14	55,2	40,8	2637	2055	12	8	28,7	18,2	989	1070
94	173	24	14	54,6	40,6	2685	2065	12	8	28,4	18,2	1012	1074
96	172	24	14	54,0	40,5	2733	2075	12	8	28,1	18,2	1035	1080
98	171	24	14	53,4	40,3	2782	2086	12	8	27,8	18,2	1058	1085
100	170	24	14	52,8	40,1	2831	2097	12	8	27,5	18,2	1081	1090

Table B6: Joist hanger Blank 500 with external flanges: Form factors $k_{H,1}$ and $k_{H,2}$ and dimensions e_1 and e_2 ; $e_{1,0} = 30$ mm

B [mm]	H [mm]	full nailing						partial nailing					
		n_H	n_J	$k_{H,1}$	$k_{H,2}$	e_1 [mm]	e_2 [mm]	n_H	n_J	$k_{H,1}$	$k_{H,2}$	e_1 [mm]	e_2 [mm]
40	230	28	16	87,0	63,2	1845	2732	12	8	37,1	18,2	547	1113
42	229	28	16	86,2	63,0	1870	2715	12	8	36,8	18,2	559	1100
44	228	28	16	85,5	62,8	1895	2699	12	8	36,5	18,2	572	1089
45	228	28	16	85,2	62,7	1908	2692	12	8	36,3	18,2	578	1084
46	227	28	16	84,8	62,6	1921	2686	12	8	36,1	18,2	585	1079
48	226	28	16	84,1	62,4	1948	2674	12	8	35,8	18,2	598	1071
50	225	28	16	83,4	62,2	1976	2664	12	8	35,5	18,2	611	1063
51	225	28	16	83,0	62,1	1990	2659	12	8	35,3	18,2	618	1060
52	224	28	16	82,6	62,1	2004	2655	12	8	35,2	18,2	625	1057
54	223	28	16	81,9	61,9	2033	2647	12	8	34,8	18,2	640	1052
56	222	28	16	81,2	61,7	2063	2640	12	8	34,5	18,2	655	1047
58	221	28	16	80,5	61,5	2094	2635	12	8	34,2	18,2	670	1044

B [mm]	H [mm]	full nailing						partial nailing					
		n _H	n _J	k _{H,1}	k _{H,2}	e ₁ [mm]	e ₂ [mm]	n _H	n _J	k _{H,1}	k _{H,2}	e ₁ [mm]	e ₂ [mm]
60	220	28	16	79,8	61,3	2126	2631	12	8	33,8	18,2	685	1041
62	219	28	16	79,1	61,1	2158	2628	12	8	33,5	18,2	701	1039
64	218	28	16	78,4	61,0	2192	2626	12	8	33,2	18,2	718	1038
66	217	28	16	77,7	60,8	2226	2625	12	8	32,9	18,2	735	1037
68	216	28	16	77,0	60,6	2260	2625	12	8	32,5	18,2	752	1037
70	215	28	16	76,3	60,4	2296	2626	12	8	32,2	18,2	769	1037
72	214	28	16	75,6	60,3	2332	2628	12	8	31,9	18,2	787	1038
73	214	28	16	75,2	60,2	2351	2629	12	8	31,7	18,2	797	1039
74	213	28	16	74,9	60,1	2369	2631	12	8	31,6	18,2	806	1040
76	212	28	16	74,2	59,9	2407	2634	12	8	31,3	18,2	825	1042
78	211	28	16	73,5	59,7	2446	2638	12	8	30,9	18,2	844	1044
80	210	28	16	72,8	59,6	2486	2643	12	8	30,6	18,2	863	1047
82	209	28	16	72,1	59,4	2526	2649	12	8	30,3	18,2	883	1050
84	208	28	16	71,4	59,2	2567	2655	12	8	30,0	18,2	904	1053
86	207	28	16	70,7	59,1	2609	2662	12	8	29,7	18,2	925	1057
88	206	28	16	70,0	58,9	2652	2670	12	8	29,4	18,2	946	1061
90	205	28	16	69,3	58,7	2695	2678	12	8	29,0	18,2	967	1065
92	204	28	16	68,6	58,6	2740	2686	12	8	28,7	18,2	989	1070
94	203	28	16	67,9	58,4	2785	2695	12	8	28,4	18,2	1012	1074
96	202	28	16	67,3	58,2	2831	2705	12	8	28,1	18,2	1035	1080
98	201	28	16	66,6	58,1	2877	2715	12	8	27,8	18,2	1058	1085
100	200	28	16	65,9	57,9	2925	2726	12	8	27,5	18,2	1081	1090

Table B7: Joist hanger Blank 238 with internal flanges: Form factors k_{H,1} and k_{H,2} and dimensions e₁ and e₂; e_{1,0} = 30 mm

B [mm]	H [mm]	full nailing						partial nailing					
		n _H	n _J	k _{H,1}	k _{H,2}	e ₁ [mm]	e ₂ [mm]	n _H	n _J	k _{H,1}	k _{H,2}	e ₁ [mm]	e ₂ [mm]
40	99	4	4	8,72	1,33	388	132	4	2	8,72	1,33	388	132
42	98	4	4	8,59	1,33	412	135	4	2	8,59	1,33	412	135
44	97	4	4	8,46	1,33	437	139	4	2	8,46	1,33	437	139
45	97	4	4	8,40	1,33	450	141	4	2	8,40	1,33	450	141
46	96	4	4	8,33	1,33	463	142	4	2	8,33	1,33	463	142
48	95	4	4	8,20	1,33	489	146	4	2	8,20	1,33	489	146
50	94	4	4	8,08	1,33	516	150	4	2	8,08	1,33	516	150
51	94	4	4	8,01	1,33	530	151	4	2	8,01	1,33	530	151
52	93	4	4	7,95	1,33	544	153	4	2	7,95	1,33	544	153
54	92	4	4	7,82	1,33	573	157	4	2	7,82	1,33	573	157
56	91	4	4	7,69	1,33	603	161	4	2	7,69	1,33	603	161
58	90	4	4	7,56	1,33	633	164	4	2	7,56	1,33	633	164
60	89	4	4	7,43	1,33	664	168	4	2	7,43	1,33	664	168
62	88	4	4	7,30	1,33	696	172	4	2	7,30	1,33	696	172
64	87	4	4	7,18	1,33	729	176	4	2	7,18	1,33	729	176
66	86	4	4	7,05	1,33	763	179	4	2	7,05	1,33	763	179
68	85	4	4	6,92	1,33	797	183	4	2	6,92	1,33	797	183
70	84	4	4	6,79	1,33	832	187	4	2	6,79	1,33	832	187
72	83	4	4	6,66	1,33	868	191	4	2	6,66	1,33	868	191
73	83	4	4	6,60	1,33	886	193	4	2	6,60	1,33	886	193
74	82	4	4	6,54	1,33	905	195	4	2	6,54	1,33	905	195
76	81	4	4	6,41	1,33	943	198	4	2	6,41	1,33	943	198
78	80	4	4	6,28	1,33	981	202	4	2	6,28	1,33	981	202
80	79	4	4	6,16	1,33	1020	206	4	2	6,16	1,33	1020	206
82	78	4	4	6,03	1,33	1060	210	4	2	6,03	1,33	1060	210
84	77	4	4	5,90	1,33	1101	214	4	2	5,90	1,33	1101	214

B [mm]	H [mm]	full nailing						partial nailing					
		n _H	n _J	k _{H,1}	k _{H,2}	e ₁ [mm]	e ₂ [mm]	n _H	n _J	k _{H,1}	k _{H,2}	e ₁ [mm]	e ₂ [mm]
86	76	4	4	5,78	1,33	1143	218	4	2	5,78	1,33	1143	218
88	75	4	4	5,65	1,33	1185	221	4	2	5,65	1,33	1185	221
90	74	4	4	5,53	1,33	1228	225	4	2	5,53	1,33	1228	225
92	73	4	4	5,40	1,33	1272	229	4	2	5,40	1,33	1272	229
94	72	4	4	5,28	1,33	1317	233	4	2	5,28	1,33	1317	233
96	71	4	4	5,15	1,33	1363	237	4	2	5,15	1,33	1363	237
98	70	4	4	5,03	1,33	1409	241	4	2	5,03	1,33	1409	241
100	69	4	4	4,90	1,33	1456	245	4	2	4,90	1,33	1456	245

Table B8: Joist hanger Blank 260 with internal flanges: Form factors k_{H,1} and k_{H,2} and dimensions e₁ and e₂; e_{1,0} = 30 mm

B [mm]	H [mm]	full nailing						partial nailing					
		n _H	n _J	k _{H,1}	k _{H,2}	e ₁ [mm]	e ₂ [mm]	n _H	n _J	k _{H,1}	k _{H,2}	e ₁ [mm]	e ₂ [mm]
40	110	4	4	8,72	1,33	103	82	4	2	8,72	1,33	103	82
42	109	4	4	8,59	1,33	113	84	4	2	8,59	1,33	113	84
44	108	4	4	8,46	1,33	124	86	4	2	8,46	1,33	124	86
45	108	4	4	8,40	1,33	130	87	4	2	8,40	1,33	130	87
46	107	4	4	8,33	1,33	136	88	4	2	8,33	1,33	136	88
48	106	4	4	8,20	1,33	149	90	4	2	8,20	1,33	149	90
50	105	4	4	8,08	1,33	163	93	4	2	8,08	1,33	163	93
51	105	4	4	8,01	1,33	170	94	4	2	8,01	1,33	170	94
52	104	4	4	7,95	1,33	177	96	4	2	7,95	1,33	177	96
54	103	4	4	7,82	1,33	192	99	4	2	7,82	1,33	192	99
56	102	4	4	7,69	1,33	208	102	4	2	7,69	1,33	208	102
58	101	4	4	7,56	1,33	225	105	4	2	7,56	1,33	225	105
60	100	4	4	7,43	1,33	243	108	4	2	7,43	1,33	243	108
62	99	4	4	7,30	1,33	261	111	4	2	7,30	1,33	261	111
64	98	4	4	7,18	1,33	280	114	4	2	7,18	1,33	280	114
66	97	4	4	7,05	1,33	300	118	4	2	7,05	1,33	300	118
68	96	4	4	6,92	1,33	321	121	4	2	6,92	1,33	321	121
70	95	4	4	6,79	1,33	343	125	4	2	6,79	1,33	343	125
72	94	4	4	6,66	1,33	365	128	4	2	6,66	1,33	365	128
73	94	4	4	6,60	1,33	376	130	4	2	6,60	1,33	376	130
74	93	4	4	6,54	1,33	388	132	4	2	6,54	1,33	388	132
76	92	4	4	6,41	1,33	412	135	4	2	6,41	1,33	412	135
78	91	4	4	6,28	1,33	437	139	4	2	6,28	1,33	437	139
80	90	4	4	6,16	1,33	463	142	4	2	6,16	1,33	463	142
82	89	4	4	6,03	1,33	489	146	4	2	6,03	1,33	489	146
84	88	4	4	5,90	1,33	516	150	4	2	5,90	1,33	516	150
86	87	4	4	5,78	1,33	544	153	4	2	5,78	1,33	544	153
88	86	4	4	5,65	1,33	573	157	4	2	5,65	1,33	573	157
90	85	4	4	5,53	1,33	603	161	4	2	5,53	1,33	603	161
92	84	4	4	5,40	1,33	633	164	4	2	5,40	1,33	633	164
94	83	4	4	5,28	1,33	664	168	4	2	5,28	1,33	664	168
96	82	4	4	5,15	1,33	696	172	4	2	5,15	1,33	696	172
98	81	4	4	5,03	1,33	729	176	4	2	5,03	1,33	729	176
100	80	4	4	4,90	1,33	763	179	4	2	4,90	1,33	763	179

Table B10: Joist hanger Blank 320 with internal flanges: Form factors $k_{H,1}$ and $k_{H,2}$ and dimensions e_1 and e_2 ; $e_{1,0} = 30$ mm

B [mm]	H [mm]	full nailing						partial nailing					
		n_H	n_J	$k_{H,1}$	$k_{H,2}$	e_1 [mm]	e_2 [mm]	n_H	n_J	$k_{H,1}$	$k_{H,2}$	e_1 [mm]	e_2 [mm]
40	140	6	8	13,9	3,33	127	203	6	4	13,9	3,33	127	203
42	139	6	8	13,7	3,33	135	200	6	4	13,7	3,33	135	200
44	138	6	8	13,5	3,33	143	197	6	4	13,5	3,33	143	197
45	138	6	8	13,4	3,33	148	197	6	4	13,4	3,33	148	197
46	137	6	8	13,3	3,33	152	196	6	4	13,3	3,33	152	196
48	136	6	8	13,1	3,33	162	196	6	4	13,1	3,33	162	196
50	135	6	8	13,0	3,33	172	196	6	4	13,0	3,33	172	196
51	135	6	8	12,9	3,33	177	197	6	4	12,9	3,33	177	197
52	134	6	8	12,8	3,33	183	197	6	4	12,8	3,33	183	197
54	133	6	8	12,6	3,33	194	199	6	4	12,6	3,33	194	199
56	132	6	8	12,4	3,33	206	201	6	4	12,4	3,33	206	201
58	131	6	8	12,2	3,33	219	203	6	4	12,2	3,33	219	203
60	130	6	8	12,0	3,33	232	206	6	4	12,0	3,33	232	206
62	129	6	8	11,8	3,33	246	209	6	4	11,8	3,33	246	209
64	128	6	8	11,7	3,33	260	212	6	4	11,7	3,33	260	212
66	127	6	8	11,5	3,33	275	216	6	4	11,5	3,33	275	216
68	126	6	8	11,3	3,33	291	219	6	4	11,3	3,33	291	219
70	125	6	8	11,1	3,33	307	223	6	4	11,1	3,33	307	223
72	124	12	8	22,7	7,43	342	306	6	4	13,0	3,33	324	227
73	124	12	8	22,5	7,43	351	309	6	4	12,9	3,33	332	229
74	123	12	8	22,3	7,43	360	311	6	4	12,8	3,33	341	231
76	122	12	8	21,9	7,43	378	316	6	4	12,6	3,33	359	235
78	121	12	8	21,6	7,43	397	321	6	4	12,4	3,33	378	240
80	120	12	8	21,2	7,43	417	327	6	4	12,2	3,33	397	244
82	119	12	8	20,9	7,43	438	333	6	4	12,0	3,33	417	249
84	118	12	8	20,5	7,43	460	340	6	4	11,8	3,33	437	253
86	117	12	8	20,2	7,43	482	346	6	4	11,7	3,33	458	258
88	116	12	8	19,8	7,43	506	354	6	4	11,5	3,33	480	263
90	115	12	8	19,5	7,43	531	361	6	4	11,3	3,33	502	268
92	114	12	8	19,1	7,43	556	369	6	4	11,1	3,33	525	273
94	113	12	8	18,8	7,43	583	376	6	4	10,9	3,33	548	278
96	112	12	8	18,4	7,43	611	384	6	4	10,8	3,33	572	283
98	111	12	8	18,1	7,43	639	393	6	4	10,6	3,33	597	288
100	110	12	8	17,7	7,43	668	401	6	4	10,4	3,33	622	293

Table B11: Joist hanger Blank 380 with internal flanges: Form factors $k_{H,1}$ and $k_{H,2}$ and dimensions e_1 and e_2 ; $e_{1,0} = 30$ mm

B [mm]	H [mm]	full nailing						partial nailing					
		n_H	n_J	$k_{H,1}$	$k_{H,2}$	e_1 [mm]	e_2 [mm]	n_H	n_J	$k_{H,1}$	$k_{H,2}$	e_1 [mm]	e_2 [mm]
40	170	8	10	17,7	28,5	767	1842	8	5	17,7	28,5	767	1842
42	169	8	10	17,5	28,2	763	1697	8	5	17,5	28,2	763	1697
44	168	8	10	17,3	27,9	760	1573	8	5	17,3	27,9	760	1573
45	168	8	10	17,2	27,7	759	1517	8	5	17,2	27,7	759	1517
46	167	8	10	17,1	27,6	757	1466	8	5	17,1	27,6	757	1466
48	166	8	10	17,0	27,2	755	1373	8	5	17,0	27,2	755	1373
50	165	8	10	16,8	26,9	754	1292	8	5	16,8	26,9	754	1292
51	165	8	10	16,7	26,8	753	1256	8	5	16,7	26,8	753	1256
52	164	8	10	16,6	26,6	753	1221	8	5	16,6	26,6	753	1221
54	163	8	10	16,4	26,3	753	1158	8	5	16,4	26,3	753	1158
56	162	8	10	16,2	26,0	753	1102	8	5	16,2	26,0	753	1102
58	161	8	10	16,1	25,7	754	1053	8	5	16,1	25,7	754	1053

B [mm]	H [mm]	full nailing						partial nailing					
		n _H	n _J	k _{H,1}	k _{H,2}	e ₁ [mm]	e ₂ [mm]	n _H	n _J	k _{H,1}	k _{H,2}	e ₁ [mm]	e ₂ [mm]
60	160	8	10	15,9	25,4	756	1008	8	5	15,9	25,4	756	1008
62	159	8	10	15,7	25,1	758	968	8	5	15,7	25,1	758	968
64	158	8	10	15,5	24,8	761	932	8	5	15,5	24,8	761	932
66	157	8	10	15,3	24,6	765	900	8	5	15,3	24,6	765	900
68	156	8	10	15,2	24,3	769	871	8	5	15,2	24,3	769	871
70	155	8	10	15,0	24,0	774	845	8	5	15,0	24,0	774	845
72	154	18	10	37,6	32,8	852	1196	8	5	18,4	9,67	337	474
73	154	18	10	37,3	32,7	856	1180	8	5	18,3	9,67	343	473
74	153	18	10	37,1	32,6	859	1165	8	5	18,2	9,67	349	473
76	152	18	10	36,6	32,4	867	1137	8	5	18,0	9,67	361	474
78	151	18	10	36,2	32,1	876	1113	8	5	17,7	9,67	373	474
80	150	18	10	35,7	31,9	886	1091	8	5	17,5	9,67	386	475
82	149	18	10	35,3	31,7	897	1071	8	5	17,3	9,67	399	477
84	148	18	10	34,8	31,5	909	1054	8	5	17,1	9,67	413	479
86	147	18	10	34,3	31,2	922	1039	8	5	16,8	9,67	427	481
88	146	18	10	33,9	31,0	936	1025	8	5	16,6	9,67	441	484
90	145	18	10	33,4	30,8	951	1014	8	5	16,4	9,67	456	487
92	144	18	10	33,0	30,6	966	1004	8	5	16,2	9,67	471	490
94	143	18	10	32,5	30,4	983	996	8	5	16,0	9,67	487	493
96	142	18	10	32,1	30,2	1001	989	8	5	15,7	9,67	503	497
98	141	18	10	31,6	30,0	1020	983	8	5	15,5	9,67	519	501
100	140	18	10	31,2	29,8	1040	979	8	5	15,3	9,67	536	505

Table B12: Joist hanger Blank 440 with internal flanges: Form factors k_{H,1} and k_{H,2} and dimensions e₁ and e₂; e_{1,0} = 30 mm

B [mm]	H [mm]	full nailing						partial nailing					
		n _H	n _J	k _{H,1}	k _{H,2}	e ₁ [mm]	e ₂ [mm]	n _H	n _J	k _{H,1}	k _{H,2}	e ₁ [mm]	e ₂ [mm]
40	200	12	14	35,7	34,6	920	3681	12	8	35,7	34,6	920	3681
42	199	12	14	35,4	34,3	917	3398	12	8	35,4	34,3	917	3398
44	198	12	14	35,1	34,1	915	3156	12	8	35,1	34,1	915	3156
45	198	12	14	35,0	34,0	914	3048	12	8	35,0	34,0	914	3048
46	197	12	14	34,8	33,9	914	2947	12	8	34,8	33,9	914	2947
48	196	12	14	34,5	33,6	913	2765	12	8	34,5	33,6	913	2765
50	195	12	14	34,2	33,4	912	2606	12	8	34,2	33,4	912	2606
51	195	12	14	34,1	33,3	912	2533	12	8	34,1	33,3	912	2533
52	194	12	14	33,9	33,2	912	2465	12	8	33,9	33,2	912	2465
54	193	12	14	33,6	32,9	913	2340	12	8	33,6	32,9	913	2340
56	192	12	14	33,3	32,7	914	2229	12	8	33,3	32,7	914	2229
58	191	12	14	33,0	32,5	915	2129	12	8	33,0	32,5	915	2129
60	190	12	14	32,8	32,2	918	2039	12	8	32,8	32,2	918	2039
62	189	12	14	32,5	32,0	920	1958	12	8	32,5	32,0	920	1958
64	188	12	14	32,2	31,8	924	1885	12	8	32,2	31,8	924	1885
66	187	12	14	31,9	31,5	927	1818	12	8	31,9	31,5	927	1818
68	186	12	14	31,6	31,3	932	1758	12	8	31,6	31,3	932	1758
70	185	12	14	31,3	31,1	937	1703	12	8	31,3	31,1	937	1703
72	184	22	12	55,8	37,8	1010	2127	12	6	30,6	18,2	536	1128
73	184	22	12	55,5	37,7	1014	2097	12	6	30,5	18,2	542	1120
74	183	22	12	55,2	37,6	1018	2070	12	6	30,3	18,2	547	1113
76	182	22	12	54,7	37,5	1026	2018	12	6	30,0	18,2	559	1100
78	181	22	12	54,1	37,3	1035	1971	12	6	29,7	18,2	572	1089
80	180	22	12	53,5	37,1	1045	1929	12	6	29,4	18,2	585	1079
82	179	22	12	53,0	36,9	1055	1890	12	6	29,0	18,2	598	1071
84	178	22	12	52,4	36,8	1067	1855	12	6	28,7	18,2	611	1063

B [mm]	H [mm]	full nailing						partial nailing					
		n _H	n _J	k _{H,1}	k _{H,2}	e ₁ [mm]	e ₂ [mm]	n _H	n _J	k _{H,1}	k _{H,2}	e ₁ [mm]	e ₂ [mm]
86	177	22	12	51,9	36,6	1079	1823	12	6	28,4	18,2	625	1057
88	176	22	12	51,3	36,4	1092	1795	12	6	28,1	18,2	640	1052
90	175	22	12	50,8	36,2	1106	1769	12	6	27,8	18,2	655	1047
92	174	22	12	50,2	36,1	1120	1746	12	6	27,5	18,2	670	1044
94	173	22	12	49,7	35,9	1136	1725	12	6	27,2	18,2	685	1041
96	172	22	12	49,1	35,7	1152	1706	12	6	26,9	18,2	701	1039
98	171	22	12	48,6	35,6	1169	1690	12	6	26,6	18,2	718	1038
100	170	22	12	48,0	35,4	1186	1675	12	6	26,3	18,2	735	1037

B.2 Characteristic load-carrying-capacities of the joist hanger connections with bolts

For joist hangers connected to a wall of concrete, lightweight concrete or to a steel member the assumptions for the calculation of the load-carrying capacity of the connection are:

- The force transfer from the joist to the joist hanger is as for a wood-wood connection, see clause B.1.
- The bolts shall always be positioned symmetrically about the vertical axis of the joist hanger.
- Washers according to EN ISO 7094 shall be installed under the bolt heads or nuts.

Description of the static model

For a downward directed force toward the bottom plate the static behaviour is basically the same as for a wood-wood connection with nails.

The fasteners in the joist are subjected to a lateral force, which is equally distributed over the nails in the joist.

Since the concrete and steel have a larger compressive strength than timber subjected perpendicular to the grain the rotation point may be assumed positioned at the top of the bottom plate.

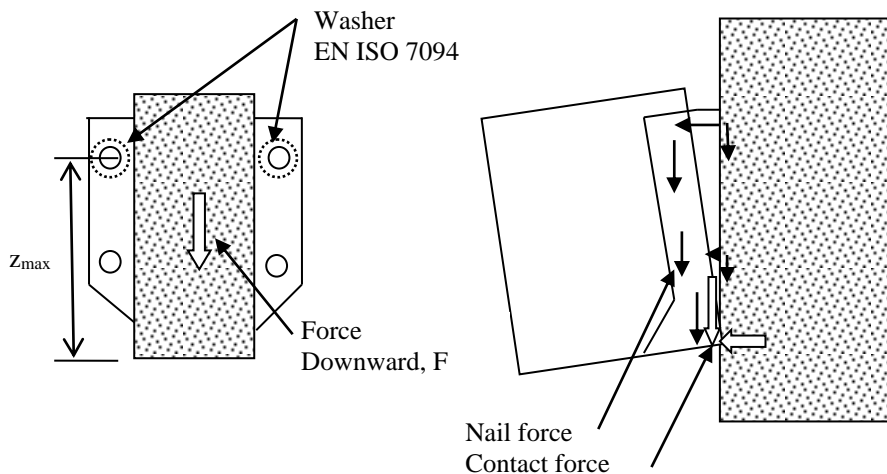

Figure B2 Left: Cross section in joist. Right: The joist will deflect and rotate, at the bottom a contact force will occur at the bottom plate, and the withdrawal forces in the bolts in the wall will vary linearly as assumed for a nailed connection in the header.

The forces in the bolts will be partly lateral forces, partly withdrawal forces. The lateral forces are distributed evenly over all bolts. The withdrawal forces are on the safe side assumed to be taken by the 2 upper bolts with washers. The maximum withdrawal force in a upper bolt can be calculated from

$$F_{ax,bolt} = \frac{F \cdot e}{2 \cdot z_{max}} \quad (B.2.1)$$

Where

F downward directed force toward the bottom plate

e eccentricity = distance from the nail column in the joist to the surface of the header.

z_max max distance from upper bolt to the bottom plate (rotation point)

The upper 2 bolts are critical. They are subjected to a lateral force and a withdrawal force. The lateral force is determined assuming an even distribution of the downward force F .

$$F_{\text{lat,bolt}} = F_{\text{Z,Ed}} / n_{\text{bolt}} \quad (\text{B.2.2})$$

Characteristic capacities of a bolted joist hanger connection

The characteristic capacity of the nail connection between the joist and the joist hanger can be calculated from the same assumptions and formulas as for joist hangers nailed to a wooden header.

$$F_{\text{Z,J,Rk}} = (n_{\text{J}} + 2) \cdot F_{\text{v,J,Rk}} \quad (\text{B.2.3})$$

The upper 2 bolts are critical. They are subjected to a lateral force calculated from formula (B.2.2).

The withdrawal force in an upper bolt is calculated from (B.2.1).

Where

$F_{\text{Z,Ed}}$ downward directed force toward the bottom plate

n_{bolt} total number of bolts in the joist hanger

e eccentricity = distance from the nail column in the joist to the surface of the header

z_{max} max distance from the upper bolt to the bottom plate (rotation point)

It shall be verified by the design of the bolted connection that the upper bolts have sufficient load-carrying design capacity to carry the combined lateral and axial forces.

From the characteristic capacity of the bearing resistance between the bolt and the plate of the joist hanger the following maximum characteristic capacity of the joist hanger connection can be determined.

$$F_{\text{bear,Rk}} = n_{\text{bolt}} \cdot f_{\text{u,k}} \cdot d \cdot t \quad (\text{B.2.4})$$

Where

n_{bolt} total number of bolts in the 2 flaps

$f_{\text{u,k}}$ characteristic ultimate tensile strength of the steel, 360 MPa

d diameter of the bolt

t thickness of the steel plate of the joist hanger

The characteristic load-carrying capacity of the joist hanger connection is the minimum of:

- The capacity determined from (B.2.3) from the nails in the joist
- The capacity determined from (B.2.4) from the embedding strength of the steel plate against the bolt
- The capacity controlled by the bolt forces given by (B.2.1) and (B.2.2).

Annex C Installation of joist hangers

Joist hanger in wood/wood connection

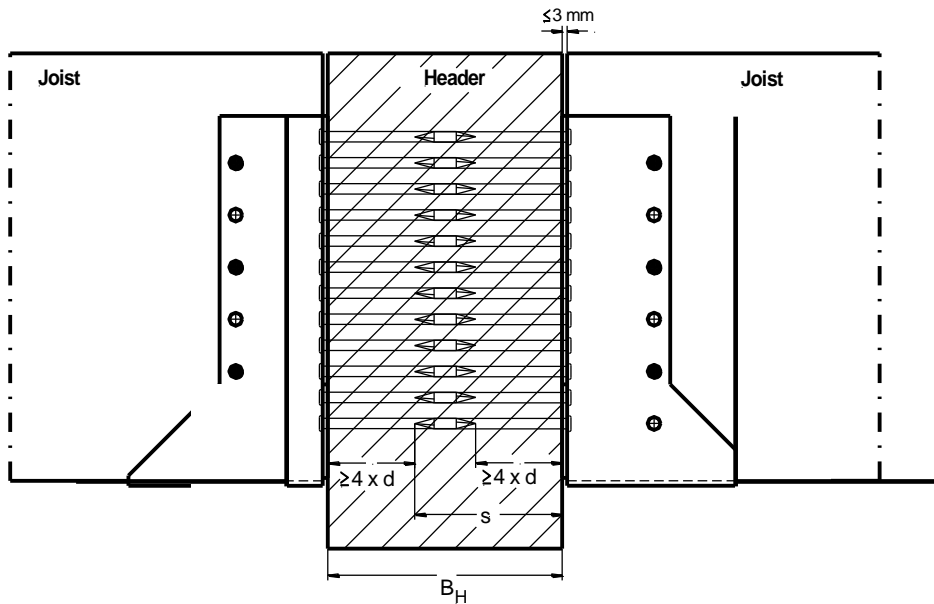
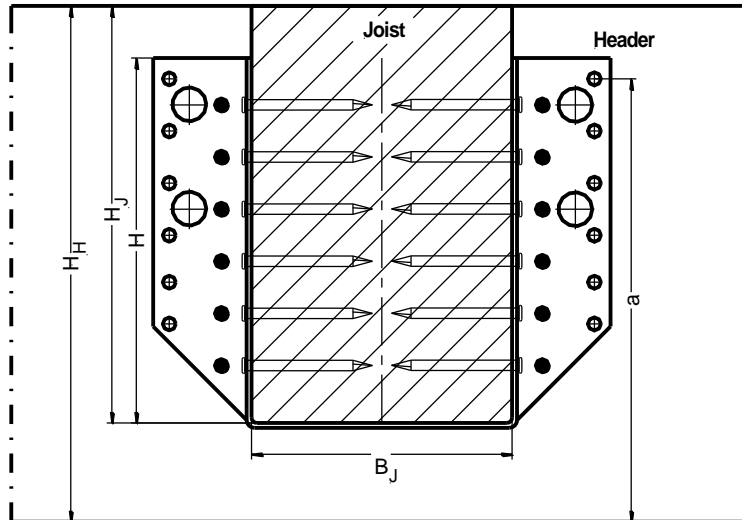

**Joist hanger connected to concrete, lightweight concrete
or a steel member by bolts**

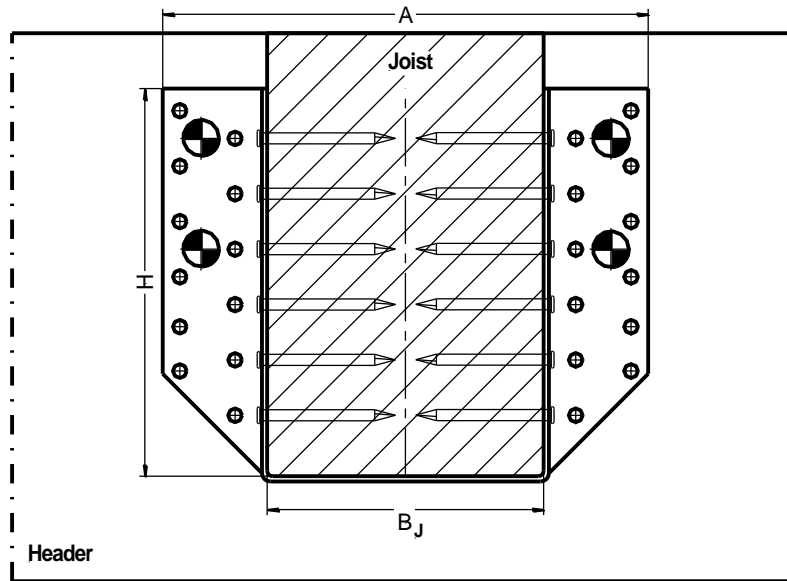

Bolts M10 or M12

Washer according to
EN ISO 7094

