



DECLARATION OF PERFORMANCE

No: 18-HY [EN]

ESSVE
GET IT DONE

Unique identification code of the product-type:

Chemical anchor ESSVE HY

Manufacturer:

ESSVE Produkter AB

BOX 7091

164 07 Kista

Sweden

info@essve.se

European Technical Assessment (ETA)	Intended use	Article numbers
ETA-18/0614 (2018-07-12)	Bonded anchor consisting of a cartridge with injection mortar ESSVE HY for use in post-installed rebar connections: <ul style="list-style-type: none">concrete strength classes C12/15 to C50/60.	All article numbers in the product group are covered by the ETA.
ETA-18/0615 (2019-02-14)	Bonded anchor consisting of a cartridge with injection mortar ESSVE HY and a steel element for use in: <ul style="list-style-type: none">cracked concrete strength classes C20/25 to C50/60.uncracked concrete strength classes C20/25 to C50/60.	All article numbers in the product group are covered by the ETA.

European Technical Assessment (ETA)	System of AVCP	European Assessment Document	Technical Assessment Body (TAB)	Notified Body (NB)
ETA-18/0614 (2018-07-12)	1	EAD 330087-00-0601, (2018-04)	DEUTSCHES INSTITUT FÜR BAUTECHNIK (DiBt)	1343 (FPC)
ETA-18/0615 (2019-02-14)	1	EAD 330499-00-0601, (2014-07)	DEUTSCHES INSTITUT FÜR BAUTECHNIK (DiBt)	1343 (FPC)



DECLARATION OF PERFORMANCE

No: 18-HY [EN]



European Technical Assessment (ETA)	Dimension & Material	Essential characteristics	Declared performance
ETA-18/0614 (2018-07-12)	Rebar $\varnothing 8$ to $\varnothing 32$ Tension Anchor ZA M12-M24	Characteristic resistance under static and quasi-static loading	Annex C1
		Reaction to fire	Class A1
		Resistance to fire	Annex C2, C3
ETA-18/0615 (2019-02-14)	Threaded rod M8 to M30 Rebar $\varnothing 8$ to $\varnothing 32$ Internal threaded rod IG-M6 to IG-M20	Characteristic resistance to tension load (static and quasi-static loading)	Annex C1, C2, C4, C5
		Characteristic resistance to shear load (static and quasi-static loading)	Annex C1, C3, C5, C7
		Displacements under short term and long-term loading	Annex C8 – C10
		Durability	Annex B1
	Threaded rod M8 to M30 (except hot-dipped) Rebar $\varnothing 8$ to $\varnothing 32$	Characteristic resistance and displacements for seismic performance category C1	Annex C2, C3, C6, C7
	Threaded rod M8 to M24 (except hot-dipped)	Characteristic resistance and displacements for seismic performance category C2	NPD
-	Content, emission and/or release of dangerous substances	NPD	

The performance of the product identified above is in conformity with the set of declared performance/s. This declaration of performance is issued, in accordance with Regulation (EU) No 305/2011, under the sole responsibility of the manufacturer above.

Signed for and on behalf of the manufacturer by:

Viktor Bukowski
Product Developer/Technical expert – Fasteners

Kista 2019-03-25

[ETA's attached as appendixes]

Approval body for construction products
and types of construction

Bautechnisches Prüfamt

An institution established by the Federal and
Laender Governments



European Technical Assessment

ETA-18/0614
of 12 July 2018

English translation prepared by DIBt - Original version in German language

General Part

Technical Assessment Body issuing the
European Technical Assessment:

Deutsches Institut für Bautechnik

Trade name of the construction product

ESSVE injection system HY for
rebar connection

Product family
to which the construction product belongs

Systems for post-installed rebar
connections with mortar

Manufacturer

ESSVE Produkter AB
Esbogatan 14
164 74 KISTA
SCHWEDEN

Manufacturing plant

ESSVE Plant No. 671

This European Technical Assessment
contains

21 pages including 3 annexes which form an integral part
of this assessment

This European Technical Assessment is
issued in accordance with Regulation (EU)
No 305/2011, on the basis of

EAD 330087-00-0601

The European Technical Assessment is issued by the Technical Assessment Body in its official language. Translations of this European Technical Assessment in other languages shall fully correspond to the original issued document and shall be identified as such.

Communication of this European Technical Assessment, including transmission by electronic means, shall be in full. However, partial reproduction may only be made with the written consent of the issuing Technical Assessment Body. Any partial reproduction shall be identified as such.

This European Technical Assessment may be withdrawn by the issuing Technical Assessment Body, in particular pursuant to information by the Commission in accordance with Article 25(3) of Regulation (EU) No 305/2011.

English translation prepared by DIBt

Specific Part

1 Technical description of the product

The subject of this European Technical Assessment is the post-installed connection, by anchoring or overlap connection joint, of reinforcing bars (rebars) in existing structures made of normal weight concrete, using the "ESSVE Injection system HY for rebar connection" in accordance with the regulations for reinforced concrete construction.

Reinforcing bars made of steel with a diameter ϕ from 8 to 32 mm or the tension anchor ZA from sizes M12 to M24 according to Annex A and injection mortar ESSVE HY are used for rebar connections. The rebar is placed into a drilled hole filled with injection mortar and is anchored via the bond between rebar, injection mortar and concrete.

The product description is given in Annex A.

2 Specification of the intended use in accordance with the applicable European assessment Document

The performances given in Section 3 are only valid if the anchor is used in compliance with the specifications and conditions given in Annex B.

The verifications and assessment methods on which this European Technical Assessment is based lead to the assumption of a working life of the rebar connection of at least 50 years. The indications given on the working life cannot be interpreted as a guarantee given by the producer, but are to be regarded only as a means for choosing the right products in relation to the expected economically reasonable working life of the works.

3 Performance of the product and references to the methods used for its assessment

3.1 Mechanical resistance and stability (BWR 1)

Essential characteristic	Performance
Characteristic resistance under static and quasi-static loading	See Annex C 1

3.2 Safety in case of fire (BWR 2)

Essential characteristic	Performance
Reaction to fire	Class A1
Resistance to fire	See Annex C 2 and C 3

4 Assessment and verification of constancy of performance (AVCP) system applied, with reference to its legal base

In accordance with European Assessment Document EAD No. 330087-00-0601, the applicable European legal act is: [96/582/EC].

The system(s) to be applied is (are): 1

English translation prepared by DIBt

5 Technical details necessary for the implementation of the AVCP system, as provided for in the applicable European Assessment Document

Technical details necessary for the implementation of the AVCP system are laid down in the control plan deposited with Deutsches Institut für Bautechnik.

Issued in Berlin on 12 July 2018 by Deutsches Institut für Bautechnik

BD Dipl.-Ing. Andreas Kummerow
Head of Department

beglaubigt:
Baderschneider

Installation post installed rebar

Figure A1: Overlapping joint for rebar connections of slabs and beams

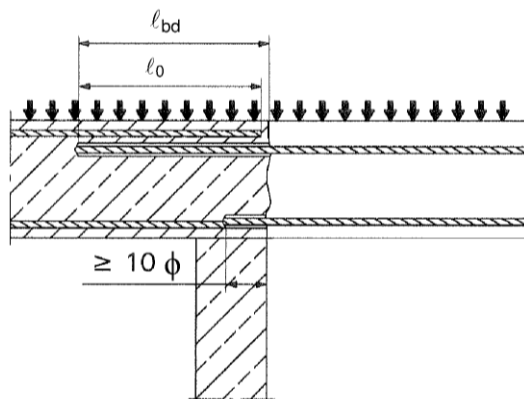

Figure A2: Overlapping joint at a foundation of a wall or column where the rebars are stressed in tension

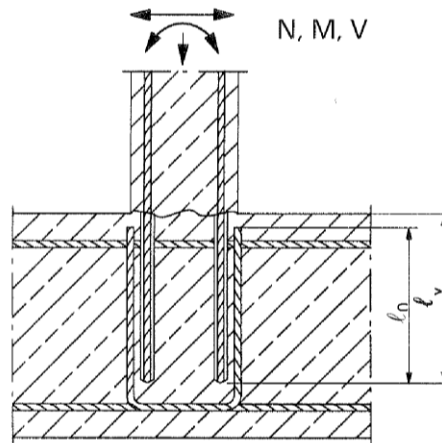

Figure A3: End anchoring of slabs or beams (e.g. designed as simply supported)

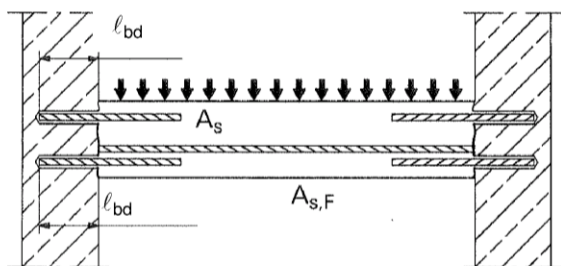

Figure A4: Rebar connection for components stressed primarily in compression. The rebars are stressed in compression

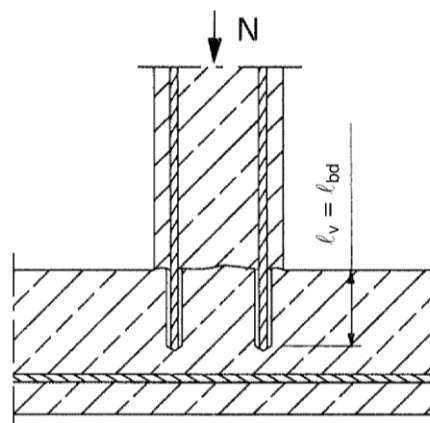
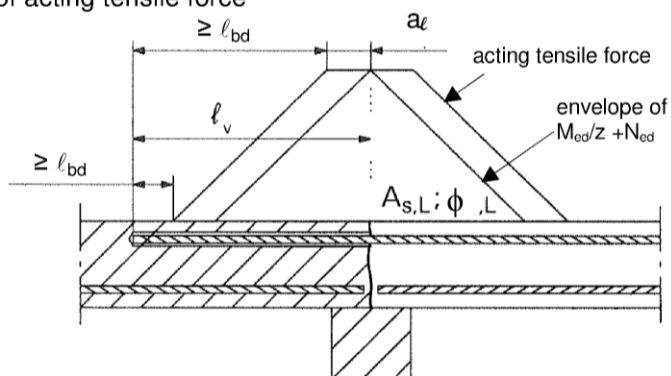

Figure A5: Anchoring of reinforcement to cover the line of acting tensile force



Note to Figure A1 to A5:

In the Figures no transverse reinforcement is plotted, the transverse reinforcement shall comply with EN 1992-1-1:2004+AC:2010.

Preparing of joints according to Annex B 2

ESSVE Injection System HY for rebar connection

Product description

Installed condition and examples of use for rebars

Annex A 1

Installation tension anchor ZA

Figure A6: Overlapping joint of a column stressed in bending to a foundation

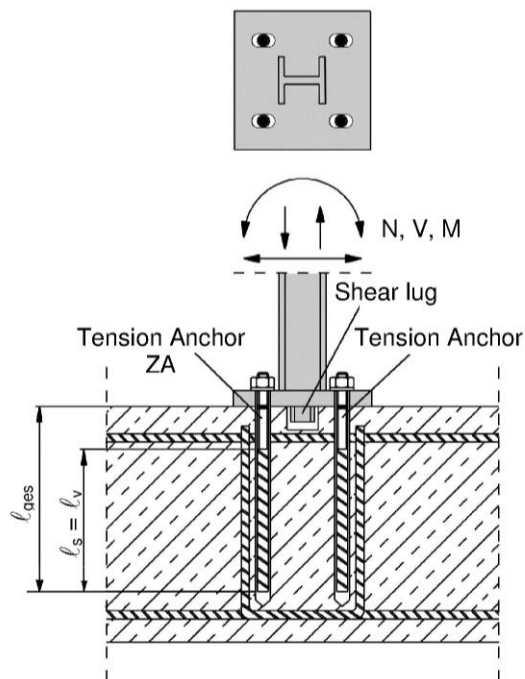

Figure A7: Overlap joint for the anchorage of barrier posts

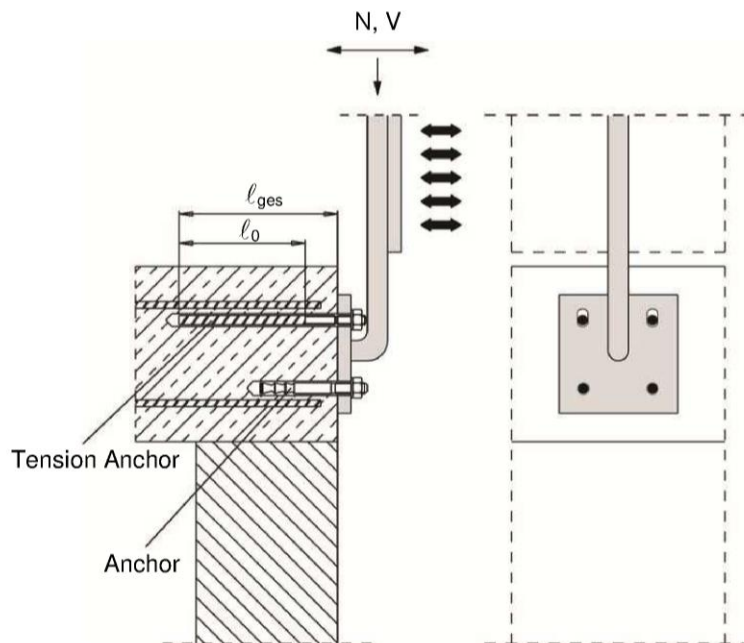
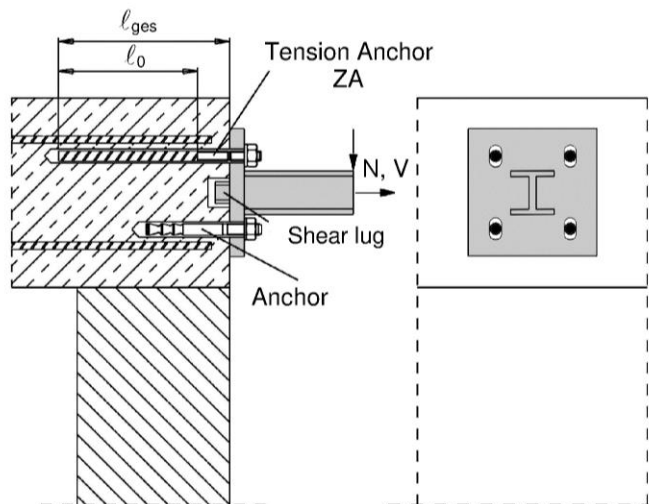

Figure A8: Overlap joint for the anchorage to cantilever members



Note to Figure A6 to A8:

In the Figures no transverse reinforcement is plotted, the transverse reinforcement shall comply with EN 1992-1-1:2002+AC:2010

ESSVE Injection System HY for rebar connection

Product description

Installed condition and examples of use for tension anchors ZA

Annex A 2

ESSVE Injection System HY:

Injection mortar: ESSVE HY

Typ "coaxial": 150 ml, 280 ml,
300 ml up to 333 ml and
380 ml up to 420 ml cartridge

Type "side-by-side":

235 ml, 345 ml and 825 ml
cartridge



Imprint: ESSVE HY, processing notes, charge-code, shelf life, hazard-code, curing- and processing time (depending on the temperature), optional with travel scale

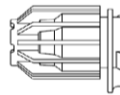

Imprint: ESSVE HY, processing notes, charge-code, shelf life, hazard-code, curing- and processing time (depending on the temperature), optional with travel scale

Static Mixer

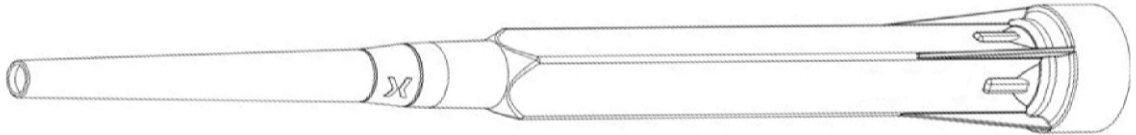

Piston plug and mixer extension

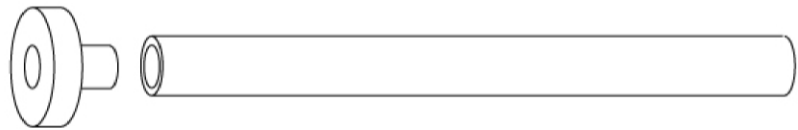

Reinforcing bar (rebar): $\varnothing 8$ to $\varnothing 32$



Tension Anchor ZA: M12 to M24

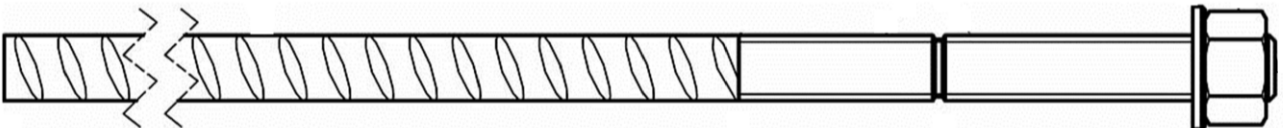

ESSVE Injection System HY for rebar connection

Product description

Injection mortar / Static mixer / Rebar / Tension Anchor ZA

Annex A 3

Reinforcing bar (rebar): $\varnothing 8, \varnothing 10, \varnothing 12, \varnothing 14, \varnothing 16, \varnothing 20, \varnothing 22, \varnothing 24, \varnothing 25, \varnothing 28, \varnothing 32$



- Minimum value of related rip area $f_{R,min}$ according to EN 1992-1-1:2004+AC:2010
- Rib height of the bar shall be in the range $0,05\phi \leq h \leq 0,07\phi$
(ϕ : Nominal diameter of the bar; h: Rip height of the bar)

Table A1: Materials

Designation	Material
Rebar EN 1992-1-1:2004+AC:2010, Annex C	Bars and de-coiled rods class B or C f_{yk} and k according to NDP or NCL of EN 1992-1-1/NA $f_{uk} = f_{tk} = k \cdot f_{yk}$

ESSVE Injection System HY for rebar connection

Product description
Specifications Rebar

Annex A 4

Tension Anchor ZA: M12, M16, M20, M24

Marking: e.g.  ZA 12 A4

-  Mark of the producer
- ZA Trade name
- 12 Rod diameter/thread
- A4 for stainless steel A4
- HCR for high corrosion resistance steel

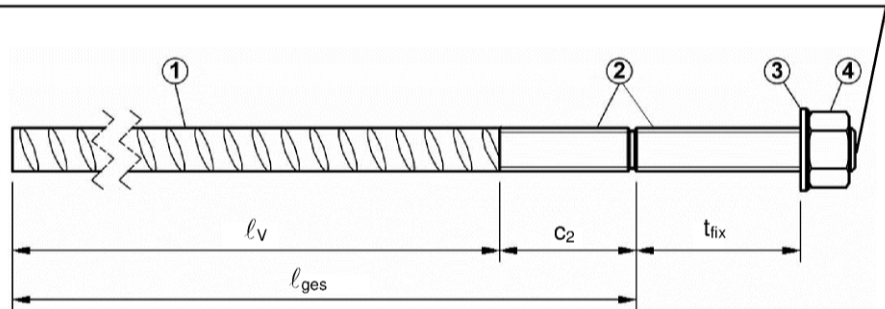

Table A2: Materials

Part	Designation	Material											
		ZA vz				ZA A4				ZA HCR			
		M12	M16	M20	M24	M12	M16	M20	M24	M12	M16	M20	M24
1	Reinforcement bar	Class B according to NDP or NCL of EN 1992-1-1/NA $f_{yk} = f_{tk} = k \cdot f_{yk}$											
2	Threaded rod	Steel, zinc plated according to EN 10087:1998 or EN 10263:2001				Stainless steel, 1.4362, 1.4401, 1.4404, 1.4571, EN 10088-1:2014				High corrosion resistant steel, 1.4529, 1.4565, EN 10088-1:2014			
		f_{yk} [N/mm ²]				f_{yk} [N/mm ²]				f_{yk} [N/mm ²]			
3	Washer	Steel, zinc plated according to EN 10087:1998 or EN 10263:2001				Stainless steel, 1.4362, 1.4401, 1.4404, 1.4571, EN 10088-1:2014				High corrosion resistant steel, 1.4529, 1.4565, EN 10088-1:2014			
4	Nut	Steel, zinc plated according to EN 10087:1998 or EN 10263:2001				Stainless steel, 1.4362, 1.4401, 1.4404, 1.4571, EN 10088-1:2014				High corrosion resistant steel, 1.4529, 1.4565, EN 10088-1:2014			

Table A3: Dimensions and installation parameter

Size			ZA-M12	ZA-M16	ZA-M20	ZA-M24	
Diameter of threaded rod		[mm]	12	16	20	24	
Diameter of reinforcement bar		[mm]	12	16	20	25	
Drill hole diameter		[mm]	16	20	25	32	
Diameter of clearance hole in fixture		[mm]	14	18	22	26	
With across nut flats	SW	[mm]	19	24	30	36	
Stress area	A _s	[mm ²]	84	157	245	353	
Effective embedment depth	l _v	[mm]	according to static calculation				
Length of bonded thread	plated	c ₂	[mm]	≥ 20	≥ 20	≥ 20	≥ 20
	A4/HCR			≥ 100	≥ 100	≥ 100	≥ 100
Minimum thickness of fixture	t _{fix}	[mm]	5	5	5	5	
Maximum thickness of fixture	t _{fix}	[mm]	3000	3000	3000	3000	
Maximum installation torque	T _{max}	[Nm]	50	100	150	150	

ESSVE Injection System HY for rebar connection

Product description
Specifications Tension Anchor ZA

Annex A 5

Specifications of intended use

Anchorage subject to:

- Static and quasi-static loads.
- Fire exposure

Base materials:

- Reinforced or unreinforced normal weight concrete according to EN 206-1:2000.
- Strength classes C12/15 to C50/60 according to EN 206-1:2000.
- Maximum chloride concrete of 0,40% (CL 0.40) related to the cement content according to EN 206-1:2000.
- Non-carbonated concrete.

Note: In case of a carbonated surface of the existing concrete structure the carbonated layer shall be removed in the area of the post-installed rebar connection with a diameter of $\phi + 60$ mm prior to the installation of the new rebar.

The depth of concrete to be removed shall correspond to at least the minimum concrete cover in accordance with EN 1992-1-1:2004+AC:2010.

The foregoing may be neglected if building components are new and not carbonated and if building components are in dry conditions.

Temperature Range:

- - 40°C to +80°C (max. short term temperature +80°C and max long term temperature +50°C).

Use conditions (Environmental conditions):

- Structures subject to dry internal conditions or subject to external atmospheric exposure (including industrial and marine environment) and to permanently damp internal condition, if no particular aggressive conditions exist (stainless steel or high corrosion resistant steel).
- Structures subject to external atmospheric exposure and to permanently damp internal condition, if other particular aggressive conditions exist (high corrosion resistant steel).

Note: Particular aggressive conditions are e.g. permanent, alternating immersion in seawater or the splash zone of seawater, chloride atmosphere of indoor swimming pools or atmosphere with extreme chemical pollution (e.g. in desulphurization plants or road tunnels where de-icing materials are used).

Design:

- Anchorages are designed under the responsibility of an engineer experienced in anchorages and concrete work.
- Verifiable calculation notes and drawings are prepared taking account of the forces to be transmitted.
- Design according to EN 1992-1-1:2004+AC:2010, EN 1992-1-2:2004+AC:2008 and Annex B 2 and B 3.
- The actual position of the reinforcement in the existing structure shall be determined on the basis of the construction documentation and taken into account when designing.

Installation:

- Dry or wet concrete.
- It must not be installed in flooded holes.
- Hole drilling by hammer drill (HD) or compressed air drill mode (CD).
- The installation of post-installed rebar resp. tension anchors shall be done only by suitable trained installer and under supervision on site; the conditions under which an installer may be considered as suitable trained and the conditions for supervision on site are up to the Member States in which the installation is done.
- Check the position of the existing rebars (if the position of existing rebars is not known, it shall be determined using a rebar detector suitable for this purpose as well as on the basis of the construction documentation and then marked on the building component for the overlap joint).

ESSVE Injection System HY for rebar connection

Intended use
Specifications

Annex B 1

Figure B1: General construction rules for post-installed rebars

- Only tension forces in the axis of the rebar may be transmitted
- The transfer of shear forces between new concrete and existing structure shall be designed additionally according to EN 1992-1-1:2004+AC:2010.
- The joints for concreting must be roughened to at least such an extent that aggregate protrude.

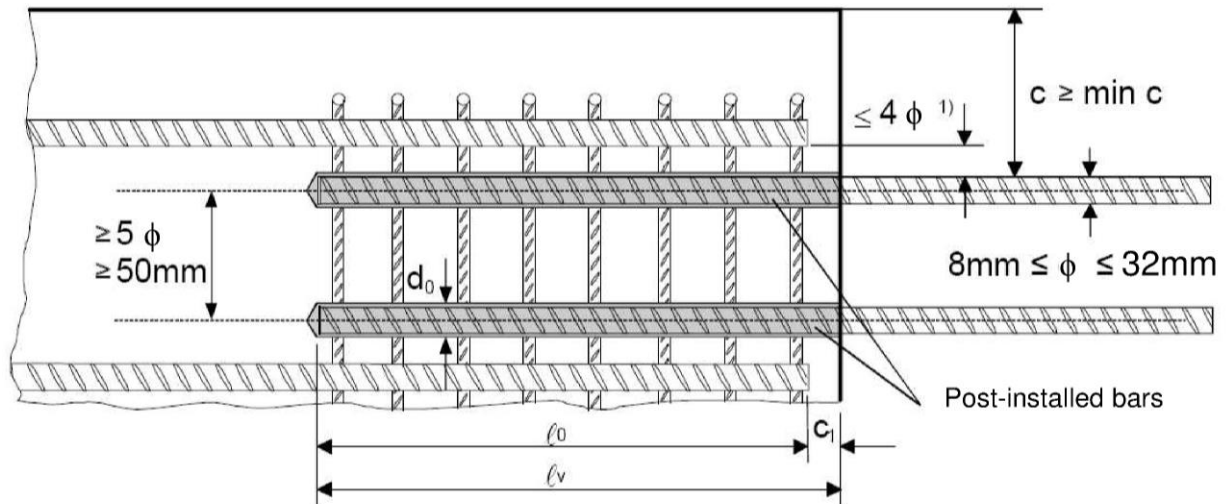

- ¹⁾ If the clear distance between lapped bars exceeds 4ϕ , then the lap length shall be increased by the difference between the clear bar distance and 4ϕ .

The following applies to Figure B1:

c	concrete cover of post-installed rebar
c_1	concrete cover at end-face of existing rebar
min c	minimum concrete cover according to Table B1 and to EN 1992-1-1:2004+AC:2010, Section 4.4.1.2
ϕ	diameter of post-installed rebar
l_0	lap length, according to EN 1992-1-1:2004+AC:2010, Section 8.7.3
l_v	effective embedment depth, $\geq l_0 + c_1$
d_0	nominal drill bit diameter, see Annex B 6

ESSVE Injection System HY for rebar connection

Intended use

General construction rules for post-installed rebars

Annex B 2

Figure B2: General construction rules for tension anchors ZA

- The length of the bonded-in thread may not be accounted as anchorage
- Only tension forces in the direction of the bar axis may be transmitted by the tension anchor ZA
- The tension force must be transferred via an overlap joint to the reinforcement in the building part.
- The transfer of shear forces shall be ensured by appropriate additional measures, e.g. shear lugs or by anchors with an European technical assessment.
- In the anchor plate, the holes for the tension anchors shall be executed as elongated holes with axis in the direction of the shear force.

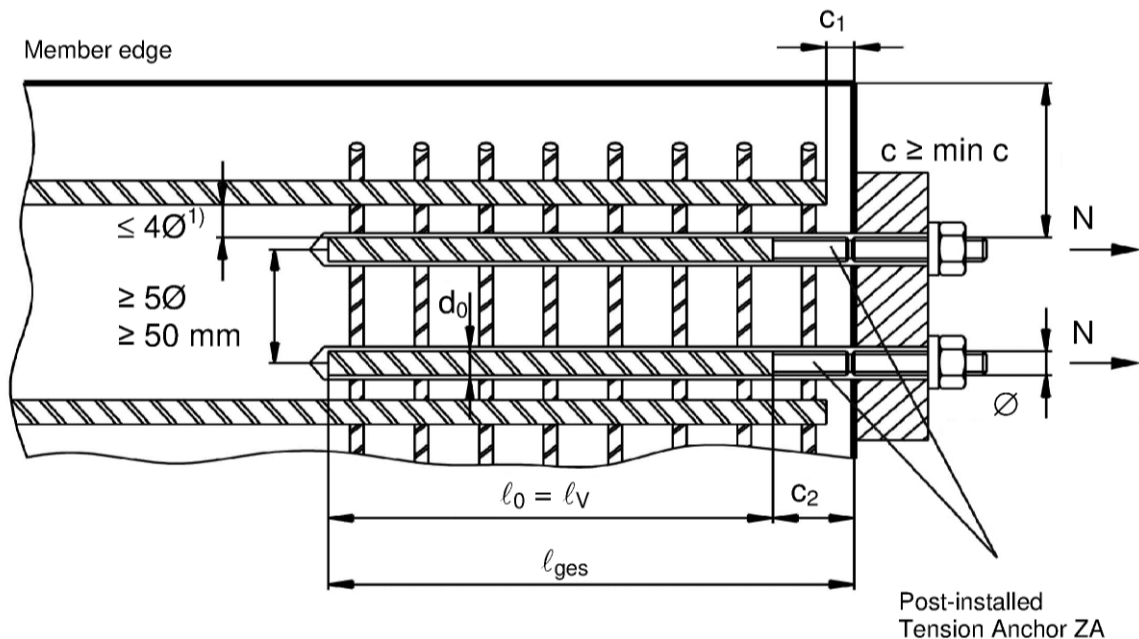

- 1) If the clear distance between lapped bars exceeds 4ϕ , then the lap length shall be increased by the difference between the clear bar distance and 4ϕ .

The following applies to Figure B2:

c	concrete cover of tension anchor ZA
c_1	concrete cover at end-face of existing rebar
c_2	Length of bonded thread
min c	minimum concrete cover according to Table B1 and to EN 1992-1-1:2004+AC:2010, Section 4.4.1.2
ϕ	diameter of tension anchor
l_0	lap length, according to EN 1992-1-1:2004+AC:2010, Section 8.7.3
l_v	effective embedment depth, $\geq l_0 + c_1$
l_{ges}	overall embedment depth, $\geq l_0 + c_2$
d_0	nominal drill bit diameter, see Annex B 6

ESSVE Injection System HY for rebar connection

Intended use
General construction rules for tension anchors

Annex B 3

Table B1: Minimum concrete cover $\min c^{1)}$ of post-installed rebar depending of drilling method

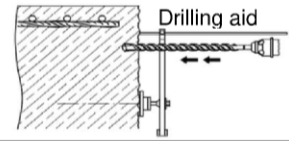

Drilling method	Rebar diameter	Without drilling aid	With drilling aid
Hammer drilling (HD)	< 25 mm	$30 \text{ mm} + 0,06 \cdot l_v \geq 2 \phi$	$30 \text{ mm} + 0,02 \cdot l_v \geq 2 \phi$
	$\geq 25 \text{ mm}$	$40 \text{ mm} + 0,06 \cdot l_v \geq 2 \phi$	$40 \text{ mm} + 0,02 \cdot l_v \geq 2 \phi$
Compressed air drilling (CD)	< 25 mm	$50 \text{ mm} + 0,08 \cdot l_v$	$50 \text{ mm} + 0,02 \cdot l_v$
	$\geq 25 \text{ mm}$	$60 \text{ mm} + 0,08 \cdot l_v$	$60 \text{ mm} + 0,02 \cdot l_v$

¹⁾ see Annex B2, Figures B1 and Annex B3, Figure B2
Comments: The minimum concrete cover acc. EN 1992-1-1:2004+AC:2010 must be observed

Table B2: maximum embedment depth $l_{v,max}$

Rebar	Tension anchor	$l_{v,max}$ [mm]
ϕ	ϕ	
8 mm		1000
10 mm		1000
12 mm	M12	1200
14 mm		1400
16 mm	M16	1600
20 mm	M20	2000
22 mm		2000
24 mm		2000
25 mm	M24	2000
28 mm		2000
32 mm		2000

Table B3: Base material temperature, gelling time and curing time

Concrete temperature	Gelling working time ¹⁾	Minimum curing time in dry concrete	Minimum curing time in wet concrete
- 5 °C to - 1 °C	50 min	5 h	10 h
0 °C to + 4 °C	25 min	3,5 h	7 h
+ 5 °C to + 9 °C	15 min	2 h	4 h
+ 10 °C to + 14 °C	10 min	1 h	2 h
+ 15 °C to + 19 °C	6 min	40 min	60 min
+ 20 °C to + 29 °C	3 min	30 min	60 min
+ 30 °C to + 40 °C	2 min	30 min	60 min
Cartridge temperature	+5°C to +40°C		









¹⁾ t_{gel} : maximum time from starting of mortar injection to completing of rebar setting.

ESSVE Injection System HY for rebar connection

Intended use
Minimum concrete cover
Maximum embedment depth / working time and curing times

Annex B 4

Table B4: Dispensing tools

Cartridge type/size	Hand tool		Pneumatic tool
Coaxial cartridges 150, 280, 300 up to 333 ml	 e.g. Type H 297 or H244C		 e.g. Type TS 492 X
Coaxial cartridges 380 up to 420 ml	 e.g. Type CCM 380/10	 e.g. Type H 285 or H244C	 e.g. Type TS 485 LX
Side-by-side cartridges 235, 345 ml	 e.g. Type CBM 330A	 e.g. Type H 260	 e.g. Type TS 477 LX
Side-by-side cartridge 825 ml	-	-	 e.g. Type TS 498X

All cartridges could also be extruded by a battery tool.

ESSVE Injection System HY for rebar connection

Intended Use
Dispensing tools

Annex B 5

A) Bore hole drilling

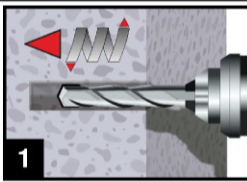

1. Drill a hole into the base material to the size and embedment depth required by the selected reinforcing bar with carbide hammer drill (HD) or a compressed air drill (CD). In case of aborted drill hole: the drill hole shall be filled with mortar.



Hammer drill (HD)

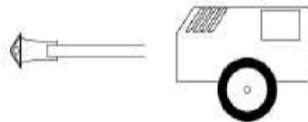

Compressed air drill (CD)

Rebar - ϕ	ZA- ϕ	Drill - ϕ [mm]
8 mm		12
10 mm		14
12 mm	M12	16
14 mm		18
16 mm	M16	20
20 mm	M20	25
22 mm		28
24 mm		32
25 mm	M24	32
28 mm		35
32 mm		40

B) Bore hole cleaning

MAC: Cleaning for bore hole diameter $d_0 \leq 20\text{mm}$ and bore hole depth $h_0 \leq 10d_s$

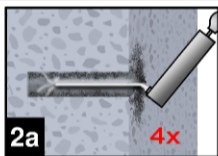

- 2a. Starting from the bottom or back of the bore hole, blow the hole clean a hand pump (Annex B 7) a minimum of four times.

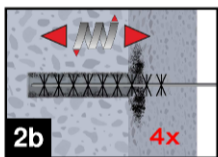

- 2b. Check brush diameter (Table B5). Brush the hole with an appropriate sized wire brush $> d_{b,min}$ (Table B5) a minimum of four times in a twisting motion. If the bore hole ground is not reached with the brush, a brush extension shall be used.

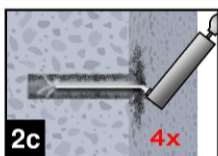

- 2c. Finally blow the hole clean again with a hand pump (Annex B 7) a minimum of four times.

CAC: Cleaning for all bore hole diameter and bore hole depth



- 2a. Starting from the bottom or back of the bore hole, blow the hole clean with compressed air (min. 6 bar) (Annex B 7) a minimum of two times until return air stream is free of noticeable dust. If the bore hole ground is not reached an extension shall be used.

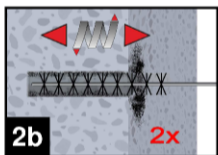

- 2b. Check brush diameter (Table B5). Brush the hole with an appropriate sized wire brush $> d_{b,min}$ (Table B5) a minimum of two times. If the bore hole ground is not reached with the brush, a brush extension shall be used (Table B5).

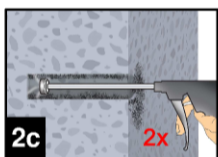

- 2c. Finally blow the hole clean again with compressed air (min. 6 bar) (Annex B 7) a minimum of two times until return air stream is free of noticeable dust. If the bore hole ground is not reached an extension shall be used.

ESSVE Injection System HY for rebar connection

Intended Use

Installation instruction: Bore hole drilling and
Bore hole cleaning

Annex B 6

Table B5: Cleaning tools

Brush RB:

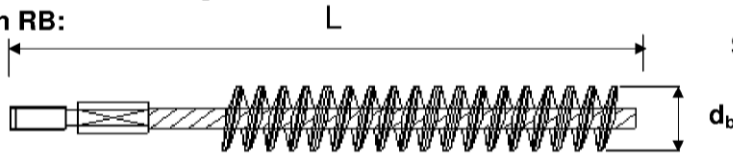

SDS Plus Adapter:



Brush extension:



ϕ Rebar	ϕ Tension anchor	d_0 Drill bit - ϕ	d_b Brush - ϕ		$d_{b,min}$ min. Brush - ϕ
(mm)	(mm)	(mm)		(mm)	
8		12	RB12	13,5	12,5
10		14	RB14	15,5	14,5
12	M12	16	RB16	17,5	16,5
14		18	RB18	20,0	18,5
16	M16	20	RB20	22,0	20,5
20	M20	25	RB25	27,0	25,5
22		28	RB28	30,0	28,5
24		32	RB32	34,0	32,5
25	M24	32	RB32	34,0	32,5
28		35	RB35	37,0	35,5
32		40	RB40	43,5	40,5



Hand pump (volume 750 ml)



Rec. compressed air tool
hand slide valve (min 6 bar)

C) Preparation of bar and cartridge

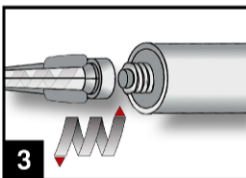

3. Attach the supplied static-mixing nozzle to the cartridge and load the cartridge into the correct dispensing tool.
For every working interruption longer than the recommended working time (Table B3) as well as for every new cartridges, a new static-mixer shall be used.

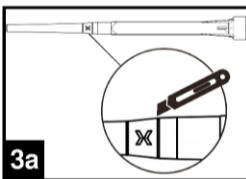

- 3a. In case of using the mixer extension VL16/1,8, the tip of the mixer nozzle has to be cut off at position „X“.

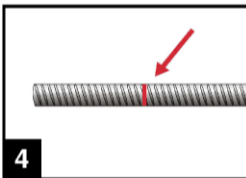

4. Prior to inserting the reinforcing bar into the filled bore hole, the position of the embedment depth shall be marked (e.g. with tape) on the reinforcing bar and insert bar in empty hole to verify hole and depth l_v .
The reinforcing bar should be free of dirt, grease, oil or other foreign material.

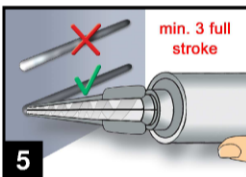

5. Prior to dispensing into the anchor hole, squeeze out separately the mortar until it shows a consistent grey colour, but a minimum of three full strokes, and discard non-uniformly mixed adhesive components.

ESSVE Injection System HY for rebar connection

Intended Use

Installation instruction: Cleaning tools and
Preparation of bar and cartridge

Annex B 7

D) Filling the bore hole

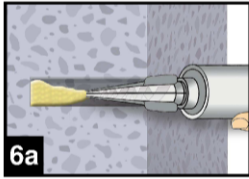

6. Starting from the bottom or back of the cleaned anchor hole fill the hole up to approximately two-thirds with adhesive. Slowly withdraw the static mixing nozzle as the hole fills to avoid creating air pockets. For embedment larger than 190 mm an extension nozzle shall be used.

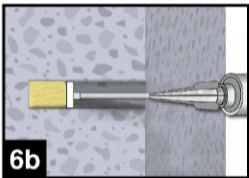

For overhead and horizontal installation and bore holes deeper than 240 mm a piston plug and the appropriate mixer extension must be used.

Observe the gel-/ working times given in Table B3.

Table B6: Piston plugs, max anchorage depth and mixer extension

Bar size ϕ [mm]	Tension anchor ϕ [mm]	Drill bit - ϕ [mm]		Piston plug	Cartridge: All sizes				Cartridge: side-by-side (825 ml)		
		HD	CD		Hand or battery tool		Pneumatic tool		Pneumatic tool		
					$l_{v,max}$ [cm]	Mixer extension	$l_{v,max}$ [cm]	Mixer extension	$l_{v,max}$ [cm]	Mixer extension	
8		12	-	-	70	VL 10/0,75	VL 10/0,75	VL 10/0,75	80	80	
10		14	-	VS14					100	100	100
12	M12	16		VS16					100	100	120
14		18		VS18					100	100	140
16	M16	20		VS20					100	100	160
20	M20	25	26	VS25	50	VL 10/0,75	VL 10/0,75	200	200	VL 16/1,8	
22		28		VS28							
24		32		VS32							
25	M24	32		VS32							
28		35		VS35							
32		40		VS40							

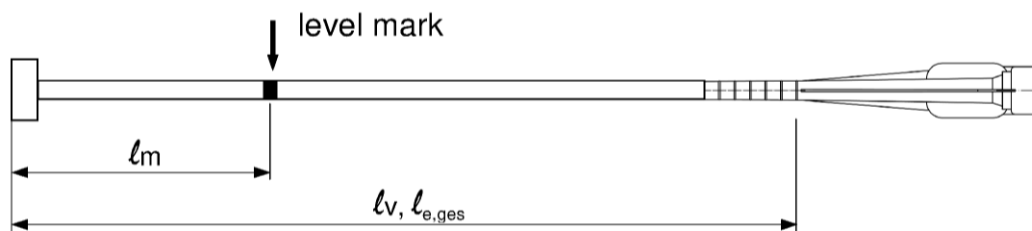

Injection tool must be marked by mortar level mark l_m and anchorage depth l_v resp. $l_{e,ges}$ with tape or marker.

Quick estimation: $l_m = 1/3 \cdot l_v$

Continue injection until the mortar level mark l_m becomes visible.

Optimum mortar volume: $l_m = l_v$ resp. $l_{e,ges} \cdot \left(1,2 \cdot \frac{\phi^2}{d_0^2} - 0,2 \right)$ [mm]

ESSVE Injection System HY for rebar connection

Intended Use

Installation instruction: Filling the bore hole

Annex B 8

E) Inserting the rebar

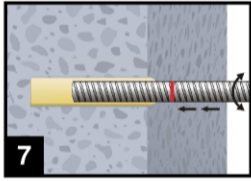

7. Push the reinforcing bar into the anchor hole while turning slightly to ensure positive distribution of the adhesive until the embedment depth is reached.

The bar should be free of dirt, grease, oil or other foreign material.

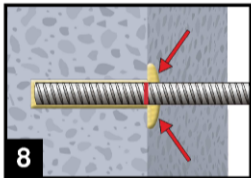

8. Be sure that the bar is inserted in the bore hole until the embedment mark is at the concrete surface and that excess mortar is visible at the top of the hole. If these requirements are not maintained, the application has to be renewed. For overhead installation fix embedded part (e.g. wedges).

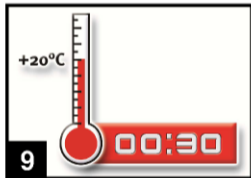

9. Observe gelling time t_{gel} . Attend that the gelling time can vary according to the base material temperature (see Table B3). It is not allowed to move the bar after gelling time t_{gel} has elapsed. Allow the adhesive to cure to the specified time prior to applying any load. Do not move or load the bar until it is fully cured (attend Table B3). After full curing time t_{cure} has elapsed, the add-on part can be installed.

ESSVE Injection System HY for rebar connection

Intended Use

Installation instruction: Inserting rebar

Annex B 9

Minimum anchorage length and minimum lap length

The minimum anchorage length $\ell_{b,min}$ and the minimum lap length $\ell_{0,min}$ according to EN 1992-1-1:2004+AC:2010 ($\ell_{b,min}$ acc. to Eq. 8.6 and Eq. 8.7 and $\ell_{0,min}$ acc. to Eq. 8.11) shall be multiplied by the amplification factor α_{4b} according to Table C1.

Table C1: Amplification factor α_{4b} related to concrete class and drilling method

Concrete class	Drilling method	Bar size	Amplification factor α_{4b}
C12/15 to C50/60	Hammer drilling and compressed air drilling	8 mm to 32 mm ZA-M12 to ZA-M24	1,0

Table C2: Reduction factor k_b for all drilling methods

Rebar - \emptyset	Concrete class									
	ϕ	C12/15	C16/20	C20/25	C25/30	C30/37	C35/45	C40/50	C45/55	C50/60
8 to 32 mm ZA-M12 to ZA-M24		1,0								

Table C3: Design values of the ultimate bond stress $f_{bd,PIR}$ in N/mm² for all drilling methods and for good conditions

$$f_{bd,PIR} = k_b \cdot f_{bd}$$

with

f_{bd} : Design value of the ultimate bond stress in N/mm² considering the concrete classes and the rebar diameter according to EN 1992-1-1:2004+AC:2010.

(for all other bond conditions multiply the values by 0.7)

k_b : Reduction factor according to Table C2

Rebar - \emptyset	Concrete class									
	ϕ	C12/15	C16/20	C20/25	C25/30	C30/37	C35/45	C40/50	C45/55	C50/60
8 to 32 mm ZA-M12 to ZA-M24		1,6	2,0	2,3	2,7	3,0	3,4	3,7	4,0	4,3

ESSVE Injection System HY for rebar connection

Performances

Amplification factor α_{4b} , Reduction factor

Design values of ultimate bond resistance $f_{bd,PIR}$

Annex C 1

Design value of the ultimate bond stress $f_{bd,fi}$ under fire exposure for concrete classes C12/15 to C50/60, (all drilling methods):

The design value of the bond stress $f_{bd,fi}$ under fire exposure has to be calculated by the following equation:

$$f_{bd,fi} = k_{fi}(\theta) \cdot f_{bd,PIR} \cdot \gamma_c / \gamma_{M,fi}$$

with: $\theta \leq 364^\circ\text{C}$: $k_{fi}(\theta) = 30,34 \cdot e^{(\theta - 0,011)} / (f_{bd,PIR} \cdot 4,3) \leq 1,0$
 $\theta > 364^\circ\text{C}$: $k_{fi}(\theta) = 0$

$f_{bd,fi}$ Design value of the ultimate bond stress in case of fire in N/mm²

θ Temperature in °C in the mortar layer.

$k_{fi}(\theta)$ Reduction factor under fire exposure.

$f_{bd,PIR}$ Design value of the ultimate bond stress in N/mm² in cold condition according to Table C3 considering the concrete classes, the rebar diameter and the bond conditions according to EN 1992-1-1:2004+AC:2010.

γ_c partially safety factor according to EN 1992-1-1:2004+AC:2010

$\gamma_{M,fi}$ partially safety factor according to EN 1992-1-2:2004+AC:2008

For evidence under fire exposure the anchorage length shall be calculated according to EN 1992-1-1:2004+AC:2010 Equation 8.3 using the temperature-dependent ultimate bond stress $f_{bd,fi}$.

Example graph of Reduction factor $k_{fi}(\theta)$ for concrete classes C20/25 for good bond conditions:

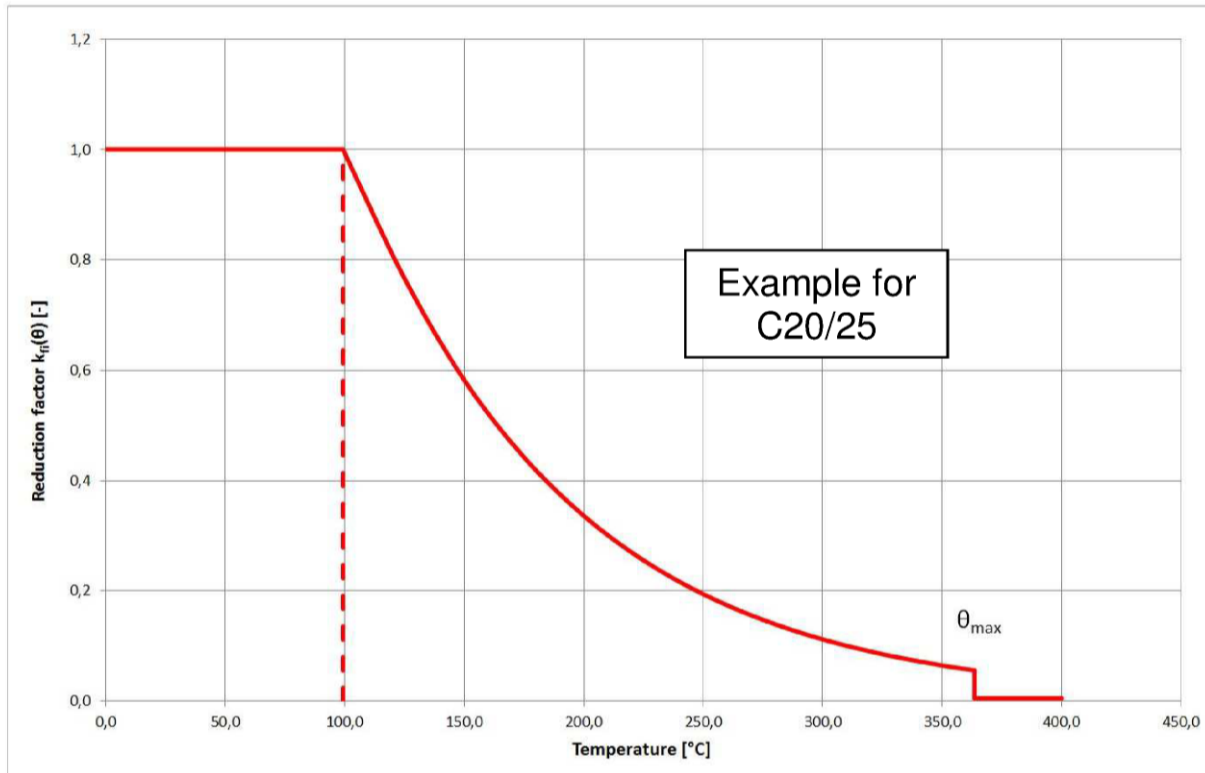

ESSVE Injection System HY for rebar connection

Performances

Design value of bond strength $f_{bd,fi}$ under fire exposure

Annex C 2

Table C4: Characteristic tension strength for tension anchor ZA under fire exposure,
concrete classes C12/15 to C50/60, according to Technical Report TR 020

Tension Anchor				M12	M16	M20	M24
Steel, zinc plated (ZA vz)							
Characteristic steel strength	R30	$\sigma_{Rk,s,fi}$	[N/mm ²]	20			
	R60			15			
	R90			13			
	R120			10			
Stainless Steel (ZA A4 or ZA HCR)							
Characteristic steel strength	R30	$\sigma_{Rk,s,fi}$	[N/mm ²]	30			
	R60			25			
	R90			20			
	R120			16			

Design value of the steel strength $\sigma_{Rd,s,fi}$ under fire exposure

The design value of the steel strength $\sigma_{Rd,s,fi}$ under fire exposure has to be calculated by the following equation:

$$\sigma_{Rd,s,fi} = \sigma_{Rk,s,fi} / \gamma_{M,fi}$$

with:

- $\sigma_{Rk,s,fi}$ characteristic steel strength according to Table C4
- $\gamma_{M,fi}$ partially safety factor according to EN 1992-1-2:2004+AC:2008

ESSVE Injection System HY for rebar connection

Performances

Design value of the steel strength $\sigma_{Rd,s,fi}$ for tension anchor ZA under fire exposure

Annex C 3

Approval body for construction products
and types of construction

Bautechnisches Prüfamt

An institution established by the Federal and
Laender Governments



European Technical Assessment

ETA-18/0615
of 14 February 2019

English translation prepared by DIBt - Original version in German language

General Part

Technical Assessment Body issuing the
European Technical Assessment:

Deutsches Institut für Bautechnik

Trade name of the construction product

Essve Injection system HY for concrete

Product family
to which the construction product belongs

Bonded fastener for use in concrete

Manufacturer

ESSVE Produkter AB
Esbogatan 14
164 74 KISTA
SCHWEDEN

Manufacturing plant

ESSVE Plant No. 671

This European Technical Assessment
contains

25 pages including 3 annexes which form an integral part
of this assessment

This European Technical Assessment is
issued in accordance with Regulation (EU)
No 305/2011, on the basis of

EAD 330499-00-0601

This version replaces

ETA-18/0615 issued on 4 September 2018

The European Technical Assessment is issued by the Technical Assessment Body in its official language. Translations of this European Technical Assessment in other languages shall fully correspond to the original issued document and shall be identified as such.

Communication of this European Technical Assessment, including transmission by electronic means, shall be in full. However, partial reproduction may only be made with the written consent of the issuing Technical Assessment Body. Any partial reproduction shall be identified as such.

This European Technical Assessment may be withdrawn by the issuing Technical Assessment Body, in particular pursuant to information by the Commission in accordance with Article 25(3) of Regulation (EU) No 305/2011.

Specific Part

1 Technical description of the product

The "Essve Injection system HY for concrete" is a bonded anchor consisting of a cartridge with injection mortar ESSVE HY and a steel element. The steel element consist of a commercial threaded rod with washer and hexagon nut in the range of M8 to M30, reinforcing bar in the range of diameter Ø8 to Ø32 mm or internal threaded rod IG-M6 to IG-M20.

The steel element is placed into a drilled hole filled with injection mortar and is anchored via the bond between metal part, injection mortar and concrete.

The product description is given in Annex A.

2 Specification of the intended use in accordance with the applicable European Assessment Document

The performances given in Section 3 are only valid if the anchor is used in compliance with the specifications and conditions given in Annex B.

The verifications and assessment methods on which this European Technical Assessment is based lead to the assumption of a working life of the anchor of at least 50 years. The indications given on the working life cannot be interpreted as a guarantee given by the producer, but are to be regarded only as a means for choosing the right products in relation to the expected economically reasonable working life of the works.

3 Performance of the product and references to the methods used for its assessment

3.1 Mechanical resistance and stability (BWR 1)

Essential characteristic	Performance
Characteristic resistance to tension load (static and quasi-static loading)	See Annex C 1, C 2, C 4, C 5
Characteristic resistance to shear load (static and quasi-static loading)	See Annex C 1, C 3, C 5, C 7
Displacements (static and quasi-static loading)	See Annex C 8, C 9, C 10
Characteristic resistance for seismic performance category C1	See Annex C 2, C 3, C 5, C 7
Characteristic resistance and displacements for seismic performance category C2	See Annex C 2, C 3, C 8

3.2 Hygiene, health and the environment (BWR 3)

Essential characteristic	Performance
Content, emission and/or release of dangerous substances	No performance assessed

4 Assessment and verification of constancy of performance (AVCP) system applied, with reference to its legal base

In accordance with the European Assessment Document EAD 330499-00-0601 the applicable European legal act is: [96/582/EC].

The system to be applied is: 1

5 Technical details necessary for the implementation of the AVCP system, as provided for in the applicable European Assessment Document

Technical details necessary for the implementation of the AVCP system are laid down in the control plan deposited at Deutsches Institut für Bautechnik.

Issued in Berlin on 14 February 2019 by Deutsches Institut für Bautechnik

BD Dipl.-Ing. Andreas Kummerow
Head of Department

beglaubigt:
Baderschneider

Installation threaded rod M8 up to M30

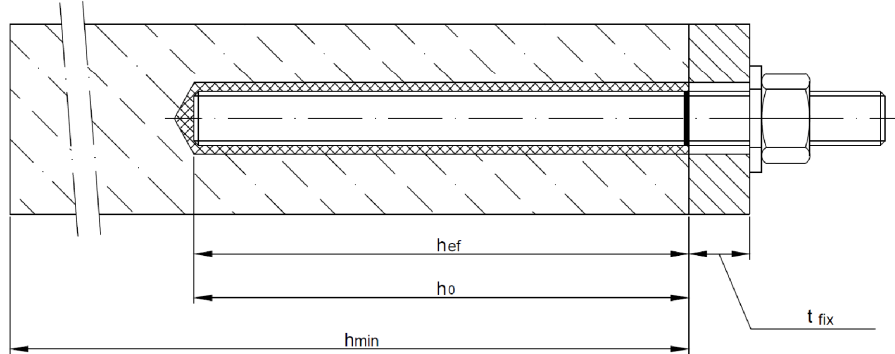

Installation reinforcing bar $\varnothing 8$ up to $\varnothing 32$

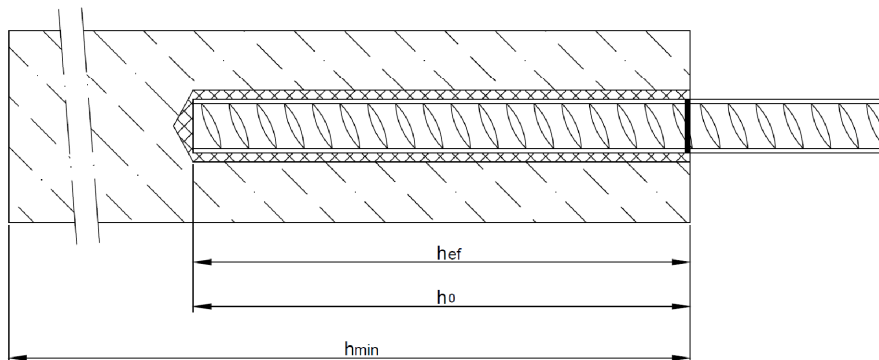

Installation internal threaded anchor rod IG-M6 up to IG-M20

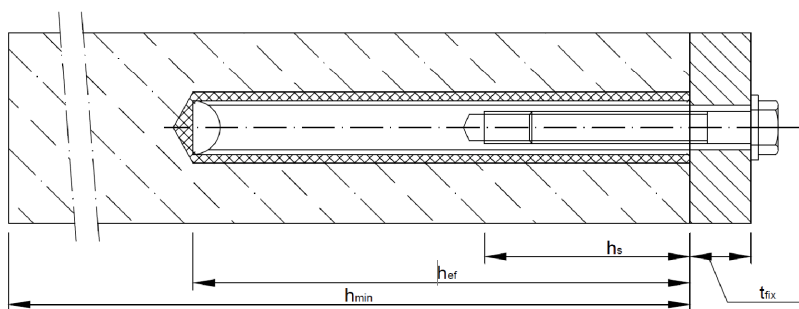

- t_{fix} = thickness of fixture
- h_{ef} = effective anchorage depth
- h_0 = depth of drill hole
- h_{min} = minimum thickness of member

Essve Injection system HY for concrete

Product description
Installed condition

Annex A 1

Cartridge: ESSVE HY

150 ml, 280 ml, 300 ml up to 333 ml and 380 ml up to 420 ml cartridge (Type: coaxial)

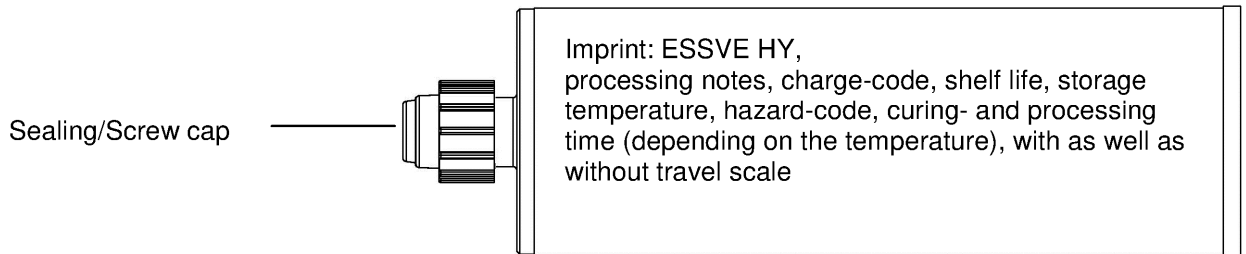

235 ml, 345 ml up to 360 ml and 825 ml cartridge (Type: “side-by-side”)

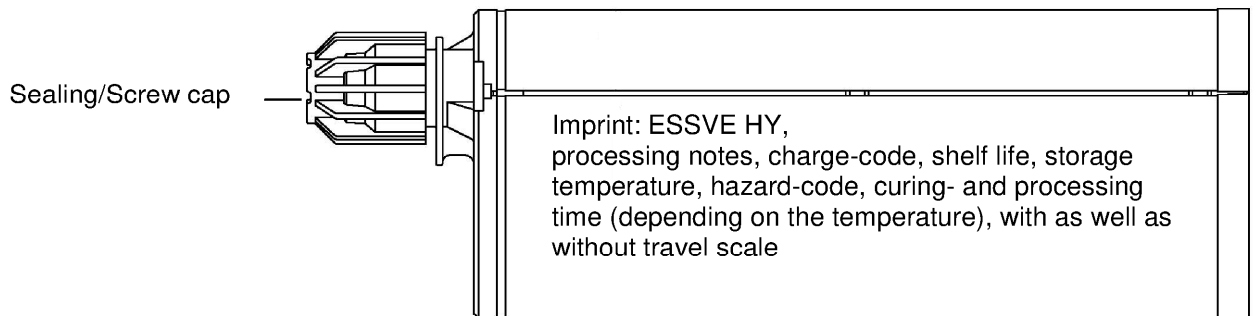

Static Mixer

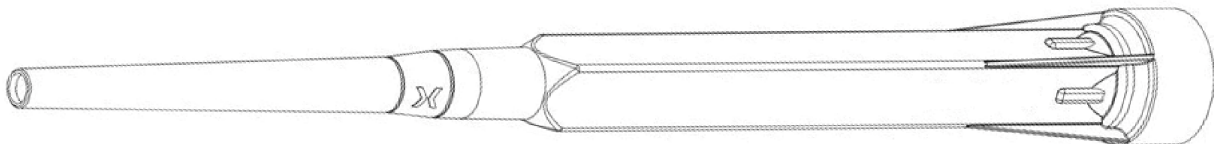

Essve Injection system HY for concrete

Product description
Injection system

Annex A 2

Threaded rod M8, M10, M12, M16, M20, M24, M27, M30 with washer and hexagon nut

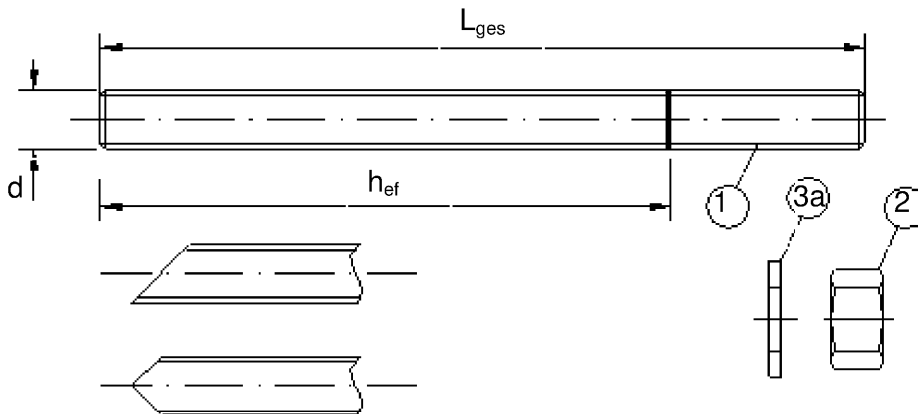

Commercial standard threaded rod with:

- Materials, dimensions and mechanical properties acc. Table A1
- Inspection certificate 3.1 acc. to EN 10204:2004
- Marking of embedment depth

Internal threaded anchor rod IG-M6, IG-M8, IG-M10, IG-M12, IG-M16, IG-M20

Threaded rod or screw

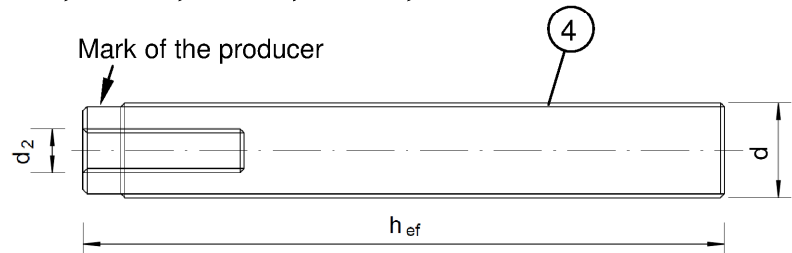
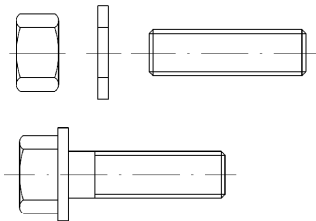

Marking: e.g.



- ┆ Marking Internal thread
- ◊ Mark

- M8 Thread size (Internal thread)
- A4 additional mark for stainless steel
- HCR additional mark for high-corrosion resistance steel

Filling washer and mixer reduction nozzle for filling the annular gap between anchor rod and fixture

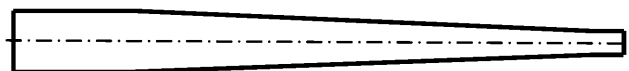
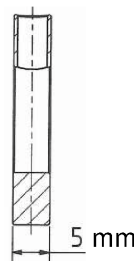
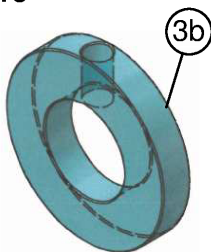

Essve Injection system HY for concrete

Product description

Threaded rod, internal threaded rod and filling washer

Annex A 3

Table A1: Materials				
Designation		Material		
Steel, zinc plated (Steel acc. to EN 10087:1998 or EN 10263:2001) zinc plated $\geq 5 \mu\text{m}$ acc. to EN ISO 4042:1999 od hot-dip galvanised $\geq 40 \mu\text{m}$ acc. to EN ISO 1461:2009 and EN ISO 10684:2004+AC:2009 or sherardized $\geq 40 \mu\text{m}$ acc. to EN ISO 17668:2016				
1	Anchor rod	Property class acc. to EN ISO 898-1:2013	4.6	$f_{uk}=400 \text{ N/mm}^2$; $f_{yk}=240 \text{ N/mm}^2$; $A_5 > 8\%$ fracture elongation
			4.8	$f_{uk}=400 \text{ N/mm}^2$; $f_{yk}=320 \text{ N/mm}^2$; $A_5 > 8\%$ fracture elongation
			5.6	$f_{uk}=500 \text{ N/mm}^2$; $f_{yk}=300 \text{ N/mm}^2$; $A_5 > 8\%$ fracture elongation
			5.8	$f_{uk}=500 \text{ N/mm}^2$; $f_{yk}=400 \text{ N/mm}^2$; $A_5 > 8\%$ fracture elongation
			8.8	$f_{uk}=800 \text{ N/mm}^2$; $f_{yk}=640 \text{ N/mm}^2$; $A_5 > 12\%$ fracture elongation ³⁾
2	Hexagon nut	Property class acc. to EN ISO 898-2:2012	4	for anchor rod class 4.6 or 4.8
			5	for anchor rod class 5.6 or 5.8
			8	for anchor rod class 8.8
3a	Washer, (z.B.: EN ISO 887:2006, EN ISO 7089:2000, EN ISO 7093:2000 oder EN ISO 7094:2000)	Steel, zinc plated, hot-dip galvanised or sherardized		
3b	Filling washer			
4	Internal threaded anchor rod	Property class acc. to EN ISO 898-1:2013	5.8	$f_{uk}=500 \text{ N/mm}^2$; $f_{yk}=400 \text{ N/mm}^2$; $A_5 > 8\%$ fracture elongation
			8.8	$f_{uk}=800 \text{ N/mm}^2$; $f_{yk}=640 \text{ N/mm}^2$; $A_5 > 8\%$ fracture elongation
Stainless steel A2 (Material 1.4301 / 1.4303 / 1.4307 / 1.4567 or 1.4541, acc. to EN 10088-1:2014) and Stainless steel A4 (Material 1.4401 / 1.4404 / 1.4571 / 1.4362 or 1.4578, acc. to EN 10088-1:2014)				
1	Anchor rod ¹⁾⁴⁾	Property class acc. to EN ISO 3506-1:2009	50	$f_{uk}=500 \text{ N/mm}^2$; $f_{yk}=210 \text{ N/mm}^2$; $A_5 > 12\%$ fracture elongation ³⁾
			70	$f_{uk}=700 \text{ N/mm}^2$; $f_{yk}=450 \text{ N/mm}^2$; $A_5 > 12\%$ fracture elongation ³⁾
			80	$f_{uk}=800 \text{ N/mm}^2$; $f_{yk}=600 \text{ N/mm}^2$; $A_5 > 12\%$ fracture elongation ³⁾
2	Hexagon nut ¹⁾⁴⁾	Property class acc. to EN ISO 3506-1:2009	50	for anchor rod class 50
			70	for anchor rod class 70
			80	for anchor rod class 80
3a	Washer, (z.B.: EN ISO 887:2006, EN ISO 7089:2000, EN ISO 7093:2000 oder EN ISO 7094:2000)	A2: Material 1.4301 / 1.4303 / 1.4307 / 1.4567 or 1.4541, EN 10088-1:2014 A4: Material 1.4401 / 1.4404 / 1.4571 / 1.4362 or 1.4578, EN 10088-1:2014		
3b	Filling washer ⁵⁾			
4	Internal threaded anchor rod ¹⁾²⁾	Property class acc. to EN ISO 3506-1:2009	50	$f_{uk}=500 \text{ N/mm}^2$; $f_{yk}=210 \text{ N/mm}^2$; $A_5 > 8\%$ fracture elongation
			70	$f_{uk}=700 \text{ N/mm}^2$; $f_{yk}=450 \text{ N/mm}^2$; $A_5 > 8\%$ fracture elongation
High corrosion resistance steel (Material 1.4529 or 1.4565, acc. to EN 10088-1: 2014)				
1	Anchor rod ¹⁾	Property class acc. to EN ISO 3506-1:2009	50	$f_{uk}=500 \text{ N/mm}^2$; $f_{yk}=210 \text{ N/mm}^2$; $A_5 > 12\%$ fracture elongation ³⁾
			70	$f_{uk}=700 \text{ N/mm}^2$; $f_{yk}=450 \text{ N/mm}^2$; $A_5 > 12\%$ fracture elongation ³⁾
			80	$f_{uk}=800 \text{ N/mm}^2$; $f_{yk}=600 \text{ N/mm}^2$; $A_5 > 12\%$ fracture elongation ³⁾
2	Hexagon nut ¹⁾	Property class acc. to EN ISO 3506-1:2009	50	for anchor rod class 50
			70	for anchor rod class 70
			80	for anchor rod class 80
3a	Washer, (z.B.: EN ISO 887:2006, EN ISO 7089:2000, EN ISO 7093:2000 oder EN ISO 7094:2000)	Material 1.4529 or 1.4565, acc. to EN 10088-1: 2014		
3b	Filling washer			
4	Internal threaded anchor rod ¹⁾²⁾	Property class acc. to EN ISO 3506-1:2009	50	$f_{uk}=500 \text{ N/mm}^2$; $f_{yk}=210 \text{ N/mm}^2$; $A_5 > 8\%$ fracture elongation
			70	$f_{uk}=700 \text{ N/mm}^2$; $f_{yk}=450 \text{ N/mm}^2$; $A_5 > 8\%$ fracture elongation
¹⁾ Property class 70 for anchor rods up to M24 and Internal threaded anchor rods up to IG-M16, ²⁾ for IG-M20 only property class 50 ³⁾ $A_5 > 8\%$ fracture elongation if <u>no</u> requirement for performance category C2 exists ⁴⁾ Property class 80 only for stainless steel A4 ⁵⁾ Filling washer only with stainless steel A4				
Essve Injection system HY for concrete				Annex A 4
Product description Materials threaded rod and internal threaded rod				

Reinforcing bar $\varnothing 8, \varnothing 10, \varnothing 12, \varnothing 14, \varnothing 16, \varnothing 20, \varnothing 24, \varnothing 25, \varnothing 28, \varnothing 32$

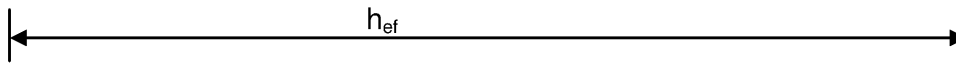
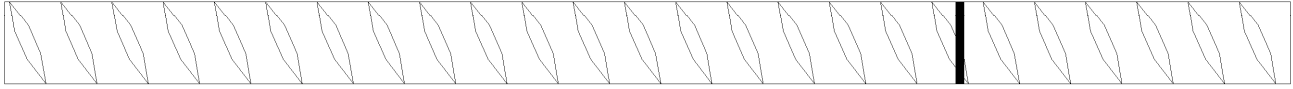

- Minimum value of related rip area $f_{R,min}$ according to EN 1992-1-1:2004+AC:2010
- Rib height of the bar shall be in the range $0,05d \leq h \leq 0,07d$
(d: Nominal diameter of the bar; h: Rip height of the bar)

Table A2: Materials

Part	Designation	Material
Reinforcing bars		
1	Rebar EN 1992-1-1:2004+AC:2010, Annex C	Bars and de-coiled rods class B or C f_{yk} and k according to NDP or NCL of EN 1992-1-1/NA $f_{uk} = f_{tk} = k \cdot f_{yk}$

Essve Injection system HY for concrete

Product description
Materials reinforcing bar

Annex A 5

Specifications of intended use

Anchorage subject to:

- Static and quasi-static loads: M8 to M30, Rebar Ø8 to Ø32, IG-M6 to IG-M20.
- Seismic action for Performance Category C1: M8 to M30 (except hot-dip galvanised rods), Rebar Ø8 to Ø32.
- Seismic action for Performance Category C2: M12 to M24 (except hot-dip galvanised rods).

Base materials:

- Reinforced or unreinforced normal weight concrete without fibres according to EN 206:2013.
- Strength classes C20/25 to C50/60 according to EN 206:2013.
- Non-cracked concrete: M8 to M30, Rebar Ø8 to Ø32, IG-M6 to IG-M20.
- Cracked concrete: M8 to M30, Rebar Ø8 to Ø32, IG-M6 to IG-M20.

Temperature Range:

- I: - 40 °C to +80 °C (max long term temperature +50 °C and max short term temperature +80 °C)
- II: - 40 °C to +120 °C (max long term temperature +72 °C and max short term temperature +120 °C)
- III: - 40 °C to +160 °C (max long term temperature +100 °C and max short term temperature +160 °C)

Use conditions (Environmental conditions):

- Structures subject to dry internal conditions (zinc coated steel, stainless steel A2 resp. A4 or high corrosion resistant steel).
- Structures subject to external atmospheric exposure (including industrial and marine environment) and to permanently damp internal condition, if no particular aggressive conditions exist (stainless steel A4 or high corrosion resistant steel).
- Structures subject to external atmospheric exposure and to permanently damp internal condition, if other particular aggressive conditions exist (high corrosion resistant steel).

Note: Particular aggressive conditions are e.g. permanent, alternating immersion in seawater or the splash zone of seawater, chloride atmosphere of indoor swimming pools or atmosphere with extreme chemical pollution (e.g. in desulphurization plants or road tunnels where de-icing materials are used).

Design:

- Verifiable calculation notes and drawings are prepared taking account of the loads to be anchored. The position of the anchor is indicated on the design drawings (e. g. position of the anchor relative to reinforcement or to supports, etc.).
- Anchorages are designed under the responsibility of an engineer experienced in anchorages and concrete work.
- The anchorages are designed in accordance to:
 - EN 1992-4:2018 and Technical Report TR055

Installation:

- Dry, wet concrete or flooded bore holes (not sea-water): M8 to M30, Rebar Ø8 to Ø32, IG-M6 to IG-M20.
- Hole drilling by hammer (HD), hollow (HDB) or compressed air drill mode (CD).
- Overhead installation allowed.
- Anchor installation carried out by appropriately qualified personnel and under the supervision of the person responsible for technical matters of the site.

Essve Injection system HY for concrete	Annex B 1
Intended Use Specifications	

Table B1: Installation parameters for threaded rod											
Anchor size		M 8	M 10	M 12	M 16	M 20	M 24	M 27	M 30		
Diameter of element	$d = d_{nom}$ [mm] =	8	10	12	16	20	24	27	30		
Nominal drill hole diameter	d_0 [mm] =	10	12	14	18	22	28	30	35		
Effective embedment depth	$h_{ef,min}$ [mm] =	60	60	70	80	90	96	108	120		
	$h_{ef,max}$ [mm] =	160	200	240	320	400	480	540	600		
Diameter of clearance hole in the fixture ¹⁾	d_f [mm] =	9	12	14	18	22	26	30	33		
Maximum torque moment	T_{inst} [Nm] ≤	10	20	40 ²⁾	60	100	170	250	300		
Minimum thickness of member	h_{min} [mm]	$h_{ef} + 30$ mm ≥ 100 mm			$h_{ef} + 2d_0$						
Minimum spacing	s_{min} [mm]	40	50	60	75	95	115	125	140		
Minimum edge distance	c_{min} [mm]	35	40	45	50	60	65	75	80		
¹⁾ For application under seismic loading the diameter of clearance hole in the fixture shall be at maximum $d_f + 1$ mm or alternatively the annular gap between fixture and anchor rod shall be filled force-fit with mortar. ²⁾ Maximum Torque moment for M12 with steel Grade 4.6 is 35 Nm											
Table B2: Installation parameters for rebar											
Rebar size		Ø 8	Ø 10	Ø 12	Ø 14	Ø 16	Ø 20	Ø 24	Ø 25	Ø 28	Ø 32
Diameter of element	$d = d_{nom}$ [mm] =	8	10	12	14	16	20	24	25	28	32
Nominal drill hole diameter	d_0 [mm] =	12	14	16	18	20	25	32	32	35	40
Effective embedment depth	$h_{ef,min}$ [mm] =	60	60	70	75	80	90	96	100	112	128
	$h_{ef,max}$ [mm] =	160	200	240	280	320	400	480	500	560	640
Minimum thickness of member	h_{min} [mm]	$h_{ef} + 30$ mm ≥ 100 mm			$h_{ef} + 2d_0$						
Minimum spacing	s_{min} [mm]	40	50	60	70	75	95	120	120	130	150
Minimum edge distance	c_{min} [mm]	35	40	45	50	50	60	70	70	75	85
Table B3: Installation parameters for Internal threaded rod											
Anchor size		IG-M 6	IG-M 8	IG-M 10	IG-M 12	IG-M 16	IG-M 20				
Internal diameter of sleeve	d_2 [mm] =	6	8	10	12	16	20				
Outer diameter of sleeve ¹⁾	$d = d_{nom}$ [mm] =	10	12	16	20	24	30				
Nominal drill hole diameter	d_0 [mm] =	12	14	18	22	28	35				
Effective embedment depth	$h_{ef,min}$ [mm] =	60	70	80	90	96	120				
	$h_{ef,max}$ [mm] =	200	240	320	400	480	600				
Diameter of clearance hole in the fixture	d_f [mm] =	7	9	12	14	18	22				
Maximum torque moment	T_{inst} [Nm] ≤	10	10	20	40	60	100				
Thread engagement length min/max	l_{IG} [mm] =	8/20	8/20	10/25	12/30	16/32	20/40				
Minimum thickness of member	h_{min} [mm]	$h_{ef} + 30$ mm ≥ 100 mm			$h_{ef} + 2d_0$						
Minimum spacing	s_{min} [mm]	50	60	75	95	115	140				
Minimum edge distance	c_{min} [mm]	40	45	50	60	65	80				
¹⁾ With metric threads according to EN 1993-1-8:2005+AC:2009											
Essve Injection system HY for concrete							Annex B 2				
Intended Use Installation parameters											

Table B4: Parameter cleaning and setting tools

Threaded Rod	Rebar	Internal threaded rod	d_0 Drill bit - Ø HD, HDB, CA	d_b Brush - Ø		$d_{b,min}$ min. Brush - Ø	Piston plug	Installation direction and use of piston plug		
				[mm]	[mm]			[mm]	↓	→
M8			10	RB10	11,5	10,5	No plug required			
M10	8	IG-M6	12	RB12	13,5	12,5				
M12	10	IG-M8	14	RB14	15,5	14,5				
	12		16	RB16	17,5	16,5				
M16	14	IG-M10	18	RB18	20,0	18,5	VS18	$h_{ef} > 250$ mm	$h_{ef} > 250$ mm	all
	16		20	RB20	22,0	20,5	VS20			
M20		IG-M12	22	RB22	24,0	22,5	VS22			
	20		25	RB25	27,0	25,5	VS25			
M24		IG-M16	28	RB28	30,0	28,5	VS28			
M27			30	RB30	31,8	30,5	VS30			
	24 / 25		32	RB32	34,0	32,5	VS32			
M30	28	IG-M20	35	RB35	37,0	35,5	VS35			
	32		40	RB40	43,5	40,5	VS40			



MAC - Hand pump (volume 750 ml)
Drill bit diameter (d_0): 10 mm to 20 mm
Drill hole depth (h_0): < 10 d_s
Only in non-cracked concrete



CAC - Rec. compressed air tool (min 6 bar)
Drill bit diameter (d_0): all diameters

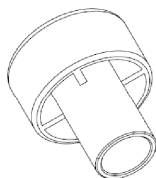

Piston plug for overhead or horizontal installation VS
Drill bit diameter (d_0): 18 mm to 40 mm



Steel brush RB
Drill bit diameter (d_0): all diameters

Essve Injection system HY for concrete

Intended Use
Cleaning and setting tools

Annex B 3

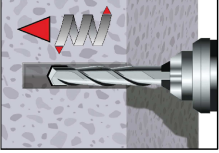
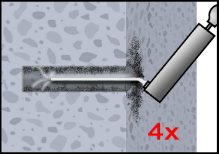
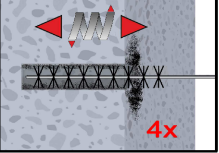
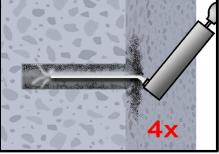
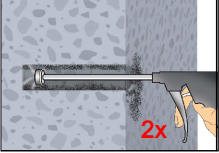
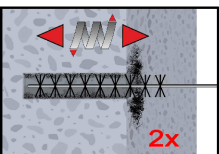
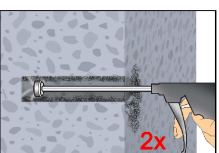
Installation instructions	
Drilling of the bore hole	
	<p>1. Drill with hammer drill a hole into the base material to the size and embedment depth required by the selected anchor (Table B1, B2, or B3), with hammer (HD), hollow (HDB) or compressed air drilling. The use of a hollow drill bit is only in combination with a sufficient vacuum permitted. In case of aborted drill hole: The drill hole shall be filled with mortar.</p>
Attention! Standing water in the bore hole must be removed before cleaning.	
MAC: Cleaning for bore hole diameter $d_0 \leq 20\text{mm}$ and bore hole depth $h_0 \leq 10d_{\text{nom}}$ (uncracked concrete only!)	
	2a. Starting from the bottom or back of the bore hole, blow the hole clean by a hand pump (Annex B 3) a minimum of four times.
	2b. Check brush diameter (Table B4). Brush the hole with an appropriate sized wire brush $> d_{b,\text{min}}$ (Table B4) a minimum of four times in a twisting motion. If the bore hole ground is not reached with the brush, a brush extension must be used.
	2c. Finally blow the hole clean again with a hand pump (Annex B 3) a minimum of four times.
CAC: Cleaning for all bore hole diameter in uncracked and cracked concrete	
	2a. Starting from the bottom or back of the bore hole, blow the hole clean with compressed air (min. 6 bar) (Annex B 3) a minimum of two times until return air stream is free of noticeable dust. If the bore hole ground is not reached an extension must be used.
	2b. Check brush diameter (Table B4). Brush the hole with an appropriate sized wire brush $> d_{b,\text{min}}$ (Table B4) a minimum of two times in a twisting motion. If the bore hole ground is not reached with the brush, a brush extension must be used.
	2c. Finally blow the hole clean again with compressed air (min. 6 bar) (Annex B 3) a minimum of two times until return air stream is free of noticeable dust. If the bore hole ground is not reached an extension must be used.
After cleaning, the bore hole has to be protected against re-contamination in an appropriate way, until dispensing the mortar in the bore hole. If necessary, the cleaning has to be repeated directly before dispensing the mortar. In-flowing water must not contaminate the bore hole again.	
Essve Injection system HY for concrete	Annex B 4
Intended Use Installation instructions	

Installation instructions (continuation)

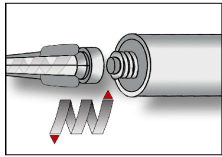

3. Attach the supplied static-mixing nozzle to the cartridge and load the cartridge into the correct dispensing tool.
For every working interruption longer than the recommended working time (Table B5) as well as for new cartridges, a new static-mixer shall be used.

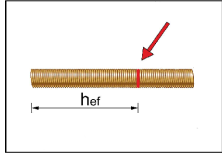

4. Prior to inserting the anchor rod into the filled bore hole, the position of the embedment depth shall be marked on the anchor rods.

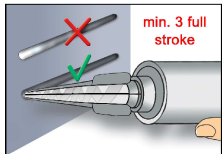

5. Prior to dispensing into the anchor hole, squeeze out separately a minimum of three full strokes and discard non-uniformly mixed adhesive components until the mortar shows a consistent grey colour.

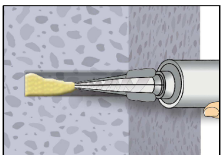

6. Starting from the bottom or back of the cleaned anchor hole, fill the hole up to approximately two-thirds with adhesive. Slowly withdraw the static mixing nozzle as the hole fills to avoid creating air pockets. If the bottom or back of the anchor hole is not reached, an appropriate extension nozzle must be used. Observe the gel-/ working times given in Table B5.

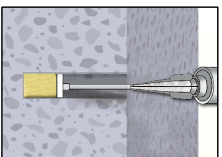

7. Piston plugs and mixer nozzle extensions shall be used according to Table B4 for the following applications:
- Horizontal assembly (horizontal direction) and ground erection (vertical downwards direction): Drill bit- $\varnothing d_0 \geq 18$ mm and embedment depth $h_{ef} > 250$ mm
 - Overhead assembly (vertical upwards direction): Drill bit- $\varnothing d_0 \geq 18$ mm

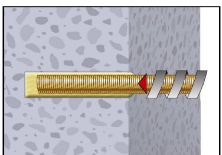

8. Push the threaded rod or reinforcing bar into the anchor hole while turning slightly to ensure positive distribution of the adhesive until the embedment depth is reached.

The anchor shall be free of dirt, grease, oil or other foreign material.

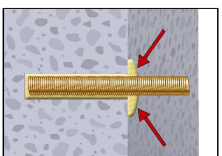

9. Be sure that the anchor is fully seated at the bottom of the hole and that excess mortar is visible at the top of the hole. If these requirements are not maintained, the application has to be renewed. For overhead application the anchor rod shall be fixed (e.g. wedges).

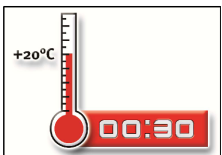

10. Allow the adhesive to cure to the specified time prior to applying any load or torque. Do not move or load the anchor until it is fully cured (attend Table B5).

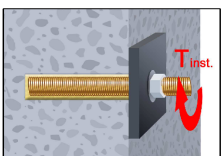

11. After full curing, the add-on part can be installed with up to the max. torque (Table B1 or B3) by using a calibrated torque wrench. It can be optional filled the annular gap between anchor and fixture with mortar. Therefor substitute the washer by the filling washer and connect the mixer reduction nozzle to the tip of the mixer. The annular gap is filled with mortar, when mortar oozes out of the washer.

Essve Injection system HY for concrete

Intended Use

Installation instructions (continuation)

Annex B 5

Table B5: Maximum working time and minimum curing time

Concrete temperature	Gelling working time	Minimum curing time in dry concrete	Minimum curing time in wet concrete
0 °C to + 4 °C	25 min	3,5 h	7 h
+ 5 °C to + 9 °C	15 min	2 h	4 h
+ 10 °C to + 14 °C	10 min	1 h	2 h
+ 15 °C to + 19 °C	6 min	40 min	80 min
+ 20 °C to + 29 °C	3 min	30 min	60 min
+ 30 °C to + 40 °C	2 min	30 min	60 min
Cartridge temperature	+5°C to +40°C		
Essve Injection system HY for concrete			Annex B 6
Intended Use Curing time			

Table C1: Characteristic values for steel tension resistance and steel shear resistance of threaded rods

Size			M 8	M 10	M 12	M 16	M 20	M 24	M 27	M 30	
Cross section area	A_s	[mm ²]	36,6	58	84,3	157	245	353	459	561	
Characteristic tension resistance, Steel failure ¹⁾											
Steel, Property class 4.6 and 4.8	$N_{Rk,s}$	[kN]	15 (13)	23 (21)	34	63	98	141	184	224	
Steel, Property class 5.6 and 5.8	$N_{Rk,s}$	[kN]	18 (17)	29 (27)	42	78	122	176	230	280	
Steel, Property class 8.8	$N_{Rk,s}$	[kN]	29 (27)	46 (43)	67	125	196	282	368	449	
Stainless steel A2, A4 and HCR, Property class 50	$N_{Rk,s}$	[kN]	18	29	42	79	123	177	230	281	
Stainless steel A2, A4 and HCR, Property class 70	$N_{Rk,s}$	[kN]	26	41	59	110	171	247	-	-	
Stainless steel A4 and HCR, Property class 80	$N_{Rk,s}$	[kN]	29	46	67	126	196	282	-	-	
Characteristic tension resistance, Partial factor ²⁾											
Steel, Property class 4.6	$\gamma_{Ms,N}$	[-]	2,0								
Steel, Property class 4.8	$\gamma_{Ms,N}$	[-]	1,5								
Steel, Property class 5.6	$\gamma_{Ms,N}$	[-]	2,0								
Steel, Property class 5.8	$\gamma_{Ms,N}$	[-]	1,5								
Steel, Property class 8.8	$\gamma_{Ms,N}$	[-]	1,5								
Stainless steel A2, A4 and HCR, Property class 50	$\gamma_{Ms,N}$	[-]	2,86								
Stainless steel A2, A4 and HCR, Property class 70	$\gamma_{Ms,N}$	[-]	1,87								
Stainless steel A4 and HCR, Property class 80	$\gamma_{Ms,N}$	[-]	1,6								
Characteristic shear resistance, Steel failure ¹⁾											
Without lever arm	Steel, Property class 4.6 and 4.8	$V_{Rk,s}^0$	[kN]	9 (8)	14 (13)	20	38	59	85	110	135
	Steel, Property class 5.6 and 5.8	$V_{Rk,s}^0$	[kN]	9 (8)	15 (13)	21	39	61	88	115	140
	Steel, Property class 8.8	$V_{Rk,s}^0$	[kN]	15 (13)	23 (21)	34	63	98	141	184	224
	Stainless steel A2, A4 and HCR, Property class 50	$V_{Rk,s}^0$	[kN]	9	15	21	39	61	88	115	140
	Stainless steel A2, A4 and HCR, Property class 70	$V_{Rk,s}^0$	[kN]	13	20	30	55	86	124	-	-
	Stainless steel A4 and HCR, Property class 80	$V_{Rk,s}^0$	[kN]	15	23	34	63	98	141	-	-
With lever arm	Steel, Property class 4.6 and 4.8	$M_{Rk,s}^0$	[Nm]	15 (13)	30 (27)	52	133	260	449	666	900
	Steel, Property class 5.6 and 5.8	$M_{Rk,s}^0$	[Nm]	19 (16)	37 (33)	65	166	324	560	833	1123
	Steel, Property class 8.8	$M_{Rk,s}^0$	[Nm]	30 (26)	60 (53)	105	266	519	896	1333	1797
	Stainless steel A2, A4 and HCR, Property class 50	$M_{Rk,s}^0$	[Nm]	19	37	66	167	325	561	832	1125
	Stainless steel A2, A4 and HCR, Property class 70	$M_{Rk,s}^0$	[Nm]	26	52	92	232	454	784	-	-
	Stainless steel A4 and HCR, Property class 80	$M_{Rk,s}^0$	[Nm]	30	59	105	266	519	896	-	-
Characteristic shear resistance, Partial factor ²⁾											
Steel, Property class 4.6	$\gamma_{Ms,V}$	[-]	1,67								
Steel, Property class 4.8	$\gamma_{Ms,V}$	[-]	1,25								
Steel, Property class 5.6	$\gamma_{Ms,V}$	[-]	1,67								
Steel, Property class 5.8	$\gamma_{Ms,V}$	[-]	1,25								
Steel, Property class 8.8	$\gamma_{Ms,V}$	[-]	1,25								
Stainless steel A2, A4 and HCR, Property class 50	$\gamma_{Ms,V}$	[-]	2,38								
Stainless steel A2, A4 and HCR, Property class 70	$\gamma_{Ms,V}$	[-]	1,56								
Stainless steel A4 and HCR, Property class 80	$\gamma_{Ms,V}$	[-]	1,33								

¹⁾ Values are only valid for the given stress area A_s . Values in brackets are valid for undersized threaded rods with smaller stress area A_s for hot-dip galvanised threaded rods according to EN ISO 10684:2004+AC:2009.

²⁾ in absence of national regulation

Essve Injection system HY for concrete

Performances

Characteristic values for steel tension resistance and steel shear resistance of threaded rods

Annex C 1

Table C2: Characteristic values of tension loads under static, quasi-static action and seismic action (performance category C1+C2)											
Anchor size threaded rod				M 8	M 10	M 12	M 16	M 20	M24	M27	M30
Steel failure											
Characteristic tension resistance		$N_{Rk,s}$	[kN]	$A_s \cdot f_{uk}$ (or see Table C1)							
		$N_{Rk,eq,C1}$	[kN]	$1,0 \cdot N_{Rk,s}$							
Characteristic tension resistance, Steel, strength class 8.8 Stainless Steel A4 and HCR, Strength class ≥ 70		$N_{Rk,eq,C2}$	[kN]	NPA	$1,0 \cdot N_{Rk,s}$					NPA	
Partial factor		$\gamma_{Ms,N}$	[-]	see Table C1							
Combined pull-out and concrete failure											
Characteristic bond resistance in non-cracked concrete C20/25											
Temperature range I: 80°C/50°C	Dry, wet concrete and flooded bore hole	$\tau_{Rk,ucr}$	[N/mm ²]	17	17	16	15	14	13	13	13
Temperature range II: 120°C/72°C		$\tau_{Rk,ucr}$	[N/mm ²]	15	14	14	13	12	12	11	11
Temperature range III: 160°C/100°C		$\tau_{Rk,ucr}$	[N/mm ²]	12	11	11	10	9,5	9,0	9,0	9,0
Characteristic bond resistance in cracked concrete C20/25											
Temperature range I: 80°C/50°C	Dry, wet concrete and flooded bore hole	$\tau_{Rk,cr} = \tau_{Rk,eq,C1}$	[N/mm ²]	7,0	7,5	8,0	9,0	8,5	7,0	7,0	7,0
		$\tau_{Rk,eq,C2}$	[N/mm ²]	NPA		3,6	3,5	3,3	2,3	NPA	
Temperature range II: 120°C/72°C		$\tau_{Rk,cr} = \tau_{Rk,eq,C1}$	[N/mm ²]	6,0	6,5	7,0	7,5	7,0	6,0	6,0	6,0
		$\tau_{Rk,eq,C2}$	[N/mm ²]	NPA		3,1	3,0	2,8	2,0	NPA	
Temperature range III: 160°C/100°C		$\tau_{Rk,cr} = \tau_{Rk,eq,C1}$	[N/mm ²]	5,5	5,5	6,0	6,5	6,0	5,5	5,5	5,5
		$\tau_{Rk,eq,C2}$	[N/mm ²]	NPA		2,5	2,7	2,5	1,8	NPA	
Increasing factors for concrete (only static or quasi-static actions) ψ_c		C25/30		1,02							
		C30/37		1,04							
		C35/45		1,07							
		C40/50		1,08							
		C45/55		1,09							
		C50/60		1,10							
Concrete cone failure											
Non-cracked concrete		$k_{ucr,N}$	[-]	11,0							
Cracked concrete		$k_{cr,N}$	[-]	7,7							
Edge distance		$c_{cr,N}$	[mm]	$1,5 h_{ef}$							
Axial distance		$s_{cr,N}$	[mm]	$2 c_{cr,N}$							
Splitting											
Edge distance	$h/h_{ef} \geq 2,0$	$c_{cr,sp}$	[mm]	$1,0 h_{ef}$							
	$2,0 > h/h_{ef} > 1,3$			$2 \cdot h_{ef} \left(2,5 - \frac{h}{h_{ef}} \right)$							
	$h/h_{ef} \leq 1,3$			$2,4 h_{ef}$							
Axial distance		$s_{cr,sp}$	[mm]	$2 c_{cr,sp}$							
Installation factor											
for dry and wet concrete (MAC)		γ_{inst}	[-]	1,2				No Performance Assessed (NPA)			
for dry and wet concrete (CAC)		γ_{inst}	[-]	1,0							
for flooded bore hole (CAC)		γ_{inst}	[-]	1,4							
Essve Injection system HY for concrete										Annex C 2	
Performances Characteristic values of tension loads under static, quasi-static action and seismic action (performance category C1+C2)											

Table C3: Characteristic values of shear loads under static, quasi-static action and seismic action (performance category C1+C2)											
Anchor size threaded rod			M 8	M 10	M 12	M 16	M 20	M24	M 27	M 30	
Steel failure without lever arm											
Characteristic shear resistance Steel, strength class 4.6 and 4.8	$V_{Rk,s}^0$	[kN]	0,6 · A _s · f _{uk} (or see Table C1)								
Characteristic shear resistance Steel, strength class 5.6, 5.8 and 8.8 Stainless Steel A2, A4 and HCR, all classes	$V_{Rk,s}^0$	[kN]	0,5 · A _s · f _{uk} (or see Table C1)								
Characteristic shear resistance (Seismic C1)	$V_{Rk,s,eq,C1}$	[kN]	0,70 · V ⁰ _{Rk,s}								
Characteristic shear resistance (Seismic C2), Steel, strength class 8.8 Stainless Steel A4 and HCR, Strength class ≥70	$V_{Rk,s,eq,C2}$	[kN]	NPA		0,70 · V ⁰ _{Rk,s}				NPA		
Partial factor	$\gamma_{Ms,V}$	[-]	see Table C1								
Ductility factor	k ₇	[-]	1,0								
Steel failure with lever arm											
Characteristic bending moment	$M_{Rk,s}^0$	[Nm]	1,2 · W _{el} · f _{uk} (or see Table C1)								
	$M_{Rk,s,eq,C1}^0$	[Nm]	No Performance Assessed (NPA)								
	$M_{Rk,s,eq,C2}^0$	[Nm]	No Performance Assessed (NPA)								
Partial factor	$\gamma_{Ms,V}$	[-]	see Table C1								
Concrete pry-out failure											
Factor	k ₈	[-]	2,0								
Installation factor	γ_{inst}	[-]	1,0								
Concrete edge failure											
Effective length of fastener	l _r	[mm]	min(h _{ef} ; 12 · d _{nom})						min(h _{ef} ; 300mm)		
Outside diameter of fastener	d _{nom}	[mm]	8	10	12	16	20	24	27	30	
Installation factor	γ_{inst}	[-]	1,0								
Factor for annular gap	α_{gap}	[-]	0,5 (1,0) ¹⁾								
¹⁾ Value in brackets valid for filled annular gap between anchor and clearance hole in the fixture. Use of special filling washer Annex A 3 is required											
Essve Injection system HY for concrete								Annex C 3			
Performances Characteristic values of shear loads under static, quasi-static action and seismic action (performance category C1+C2)											

Table C4: Characteristic values of tension loads under static and quasi-static action

Anchor size internal threaded anchor rods			IG-M 6	IG-M 8	IG-M 10	IG-M 12	IG-M 16	IG-M 20	
Steel failure¹⁾									
Characteristic tension resistance, Steel, strength class 5.8	$N_{Rk,s}$	[kN]	10	17	29	42	76	123	
Partial factor	$\gamma_{Ms,N}$	[-]	1,5						
Characteristic tension resistance, Steel, strength class 8.8	$N_{Rk,s}$	[kN]	16	27	46	67	121	196	
Partial factor	$\gamma_{Ms,N}$	[-]	1,5						
Characteristic tension resistance, Stainless Steel A4 and HCR, Strength class 70 ²⁾	$N_{Rk,s}$	[kN]	14	26	41	59	110	124	
Partial factor	$\gamma_{Ms,N}$	[-]	1,87						
Combined pull-out and concrete cone failure									
Characteristic bond resistance in non-cracked concrete C20/25									
Temperature range I: 80°C/50°C	Dry, wet concrete and flooded bore hole	$\tau_{Rk,ucr}$	[N/mm ²]	17	16	15	14	13	13
Temperature range II: 120°C/72°C		$\tau_{Rk,ucr}$	[N/mm ²]	14	14	13	12	12	11
Temperature range III: 160°C/100°C		$\tau_{Rk,ucr}$	[N/mm ²]	11	11	10	9,5	9,0	9,0
Characteristic bond resistance in cracked concrete C20/25									
Temperature range I: 80°C/50°C	Dry, wet concrete and flooded bore hole	$\tau_{Rk,cr}$	[N/mm ²]	7,5	8,0	9,0	8,5	7,0	7,0
Temperature range II: 120°C/72°C		$\tau_{Rk,cr}$	[N/mm ²]	6,5	7,0	7,5	7,0	6,0	6,0
Temperature range III: 160°C/100°C		$\tau_{Rk,cr}$	[N/mm ²]	5,5	6,0	6,5	6,0	5,5	5,5
Increasing factors for concrete ψ_c	C25/30		1,02						
	C30/37		1,04						
	C35/45		1,07						
	C40/50		1,08						
	C45/55		1,09						
	C50/60		1,10						
Concrete cone failure									
Non-cracked concrete	$k_{ucr,N}$	[-]	11,0						
Cracked concrete	$k_{cr,N}$	[-]	7,7						
Edge distance	$c_{cr,N}$	[mm]	1,5 h_{ef}						
Axial distance	$s_{cr,N}$	[mm]	2 $c_{cr,N}$						
Splitting failure									
Edge distance	$h/h_{ef} \geq 2,0$	$c_{cr,sp}$	[mm]	1,0 h_{ef}					
	$2,0 > h/h_{ef} > 1,3$			$2 \cdot h_{ef} \left(2,5 - \frac{h}{h_{ef}} \right)$					
	$h/h_{ef} \leq 1,3$			2,4 h_{ef}					
Axial distance	$s_{cr,sp}$	[mm]	2 $c_{cr,sp}$						
Installation factor									
for dry and wet concrete (MAC)	γ_{inst}	[-]	1,2			No Performance Assessed (NPA)			
for dry and wet concrete (CAC)	γ_{inst}	[-]	1,0						
for flooded bore hole (CAC)	γ_{inst}	[-]	1,4						
¹⁾ Fastening screws or threaded rods (incl. nut and washer) must comply with the appropriate material and property class of the internal threaded rod. The characteristic tension resistance for steel failure of the given strength class are valid for the internal threaded rod and the fastening element. ²⁾ For IG-M20 strength class 50 is valid									
Essve Injection system HY for concrete							Annex C 4		
Performances Characteristic values of tension loads under static and quasi-static action									

Table C5: Characteristic values of shear loads under static and quasi-static action

Anchor size for internal threaded anchor rods			IG-M 6	IG-M 8	IG-M 10	IG-M 12	IG-M 16	IG-M 20
Steel failure without lever arm¹⁾								
Characteristic shear resistance, Steel, strength class 5.8	$V_{Rk,s}^0$	[kN]	5	9	15	21	38	61
Partial factor	$\gamma_{Ms,V}$	[-]	1,25					
Characteristic shear resistance, Steel, strength class 8.8	$V_{Rk,s}^0$	[kN]	8	14	23	34	60	98
Partial factor	$\gamma_{Ms,V}$	[-]	1,25					
Characteristic shear resistance, Stainless Steel A4 and HCR, Strength class 70 ²⁾	$V_{Rk,s}^0$	[kN]	7	13	20	30	55	40
Partial factor	$\gamma_{Ms,V}$	[-]	1,56					2,38
Ductility factor	k_7	[-]	1,0					
Steel failure with lever arm¹⁾								
Characteristic bending moment, Steel, strength class 5.8	$M_{Rk,s}^0$	[Nm]	8	19	37	66	167	325
Partial factor	$\gamma_{Ms,V}$	[-]	1,25					
Characteristic bending moment, Steel, strength class 8.8	$M_{Rk,s}^0$	[Nm]	12	30	60	105	267	519
Partial factor	$\gamma_{Ms,V}$	[-]	1,25					
Characteristic bending moment, Stainless Steel A4 and HCR, Strength class 70 ²⁾	$M_{Rk,s}^0$	[Nm]	11	26	52	92	233	456
Partial factor	$\gamma_{Ms,V}$	[-]	1,56					2,38
Concrete pry-out failure								
Factor	k_8	[-]	2,0					
Installation factor	γ_{inst}	[-]	1,0					
Concrete edge failure								
Effective length of fastener	l_f	[mm]	$\min(h_{ef}; 12 \cdot d_{nom})$					$\min(h_{ef}; 300\text{mm})$
Outside diameter of fastener	d_{nom}	[mm]	10	12	16	20	24	30
Installation factor	γ_{inst}	[-]	1,0					

- ¹⁾ Fastening screws or threaded rods (incl. nut and washer) must comply with the appropriate material and property class of the internal threaded rod. The characteristic tension resistance for steel failure of the given strength class are valid for the internal threaded rod and the fastening element.
- ²⁾ For IG-M20 strength class 50 is valid

Essve Injection system HY for concrete

Performances
Characteristic values of shear loads under static and quasi-static action

Annex C 5

Table C6: Characteristic values of tension loads under static, quasi-static action and seismic action (performance category C1)

Anchor size reinforcing bar				Ø 8	Ø 10	Ø 12	Ø 14	Ø 16	Ø 20	Ø 24	Ø 25	Ø 28	Ø 32	
Steel failure														
Characteristic tension resistance	$N_{Rk,s}$	[kN]	$A_s \cdot f_{uk}^{1)}$											
	$N_{Rk,s,eq}$	[kN]	$1,0 \cdot A_s \cdot f_{uk}^{1)}$											
Cross section area	A_s	[mm ²]	50	79	113	154	201	314	452	491	616	804		
Partial factor	$\gamma_{Ms,N}$	[-]	$1,4^{2)}$											
Combined pull-out and concrete failure														
Characteristic bond resistance in non-cracked concrete C20/25														
Temperature range I: 80°C/50°C	Dry, wet concrete and flooded bore hole	$\tau_{Rk,ucr}$	[N/mm ²]	14	14	14	14	13	13	13	13	13	13	
Temperature range II: 120°C/72°C		$\tau_{Rk,ucr}$	[N/mm ²]	13	12	12	12	12	11	11	11	11	11	
Temperature range III: 160°C/100°C		$\tau_{Rk,ucr}$	[N/mm ²]	9,5	9,5	9,5	9,0	9,0	9,0	9,0	9,0	8,5	8,5	
Characteristic bond resistance in cracked concrete C20/25														
Temperature range I: 80°C/50°C	Dry, wet concrete and flooded bore hole	$\tau_{Rk,cr} = \tau_{Rk,eq}$	[N/mm ²]	5,5	5,5	6,0	6,5	6,5	6,5	6,5	7,0	7,0	7,0	
Temperature range II: 120°C/72°C		$\tau_{Rk,cr} = \tau_{Rk,eq}$	[N/mm ²]	4,5	5,0	5,0	5,5	5,5	5,5	5,5	6,0	6,0	6,0	
Temperature range III: 160°C/100°C		$\tau_{Rk,cr} = \tau_{Rk,eq}$	[N/mm ²]	4,0	4,5	4,5	5,0	5,0	5,0	5,0	5,0	5,0	5,0	
Increasing factors for concrete (only static or quasi-static actions) ψ_c	C25/30		1,02											
	C30/37		1,04											
	C35/45		1,07											
	C40/50		1,08											
	C45/55		1,09											
	C50/60		1,10											
Concrete cone failure														
Non-cracked concrete	$k_{ucr,N}$	[-]	11,0											
Cracked concrete	$k_{cr,N}$	[-]	7,7											
Edge distance	$c_{cr,N}$	[mm]	$1,5 h_{ef}$											
Axial distance	$s_{cr,N}$	[mm]	$2 c_{cr,N}$											
Splitting														
Edge distance	$h/h_{ef} \geq 2,0$	$c_{cr,sp}$	[mm]	$1,0 h_{ef}$										
	$2,0 > h/h_{ef} > 1,3$			$2 \cdot h_{ef} \left(2,5 - \frac{h}{h_{ef}} \right)$										
	$h/h_{ef} \leq 1,3$			$2,4 h_{ef}$										
Axial distance	$s_{cr,sp}$	[mm]	$2 c_{cr,sp}$											
Installation factor														
for dry and wet concrete (MAC)	γ_{inst}	[-]	1,2					No Performance Assessed (NPA)						
for dry and wet concrete (CAC)	γ_{inst}	[-]	1,0											
for flooded bore hole (CAC)	γ_{inst}	[-]	1,4											
¹⁾ f_{uk} shall be taken from the specifications of reinforcing bars ²⁾ in absence of national regulation														
Essve Injection system HY for concrete												Annex C 6		
Performances Characteristic values of tension loads under static, quasi-static action and seismic action (performance category C1)														

Table C7: Characteristic values of shear loads under static, quasi-static action and seismic action (performance category C1)														
Anchor size reinforcing bar			Ø 8	Ø 10	Ø 12	Ø 14	Ø 16	Ø 20	Ø 24	Ø 25	Ø 28	Ø 32		
Steel failure without lever arm														
Characteristic shear resistance	$V_{Rk,s}^0$	[kN]	$0,50 \cdot A_s \cdot f_{uk}^{1)}$											
	$V_{Rk,s,eq}$	[kN]	$0,35 \cdot A_s \cdot f_{uk}^{1)}$											
Cross section area	A_s	[mm ²]	50	79	113	154	201	314	452	491	616	804		
Partial factor	$\gamma_{Ms,V}$	[-]	1,5 ²⁾											
Ductility factor	k_7	[-]	1,0											
Steel failure with lever arm														
Characteristic bending moment	$M_{Rk,s}^0$	[Nm]	$1,2 \cdot W_{el} \cdot f_{uk}^{1)}$											
	$M_{Rk,s,eq}^0$	[Nm]	No Performance Assessed (NPA)											
Elastic section modulus	W_{el}	[mm ³]	50	98	170	269	402	785	896	1534	2155	3217		
Partial factor	$\gamma_{Ms,V}$	[-]	1,5 ²⁾											
Concrete pry-out failure														
Factor	k_8	[-]	2,0											
Installation factor	γ_{inst}	[-]	1,0											
Concrete edge failure														
Effective length of fastener	l_f	[mm]	$\min(h_{ef}; 12 \cdot d_{nom})$							$\min(h_{ef}; 300\text{mm})$				
Outside diameter of fastener	d_{nom}	[mm]	8	10	12	14	16	20	24	25	28	32		
Installation factor	γ_{inst}	[-]	1,0											
Factor for annular gap	α_{gap}	[-]	0,5 (1,0) ³⁾											
¹⁾ f_{uk} shall be taken from the specifications of reinforcing bars ²⁾ in absence of national regulation ³⁾ Value in brackets valid for filled annular gap between anchor and clearance hole in the fixture. Use of special filling washer Annex A 3 is required														
Essve Injection system HY for concrete										Annex C 7				
Performances Characteristic values of shear loads under static, quasi-static action and seismic action (performance category C1)														

Table C8: Displacements under tension load¹⁾ (threaded rod)										
Anchor size threaded rod			M 8	M 10	M 12	M 16	M 20	M24	M 27	M 30
Non-cracked concrete C20/25 under static and quasi-static action										
Temperature range I: 80°C/50°C	δ_{N0} -factor	[mm/(N/mm ²)]	0,031	0,032	0,034	0,037	0,039	0,042	0,044	0,046
	$\delta_{N\infty}$ -factor	[mm/(N/mm ²)]	0,040	0,042	0,044	0,047	0,051	0,054	0,057	0,060
Temperature range II: 120°C/72°C	δ_{N0} -factor	[mm/(N/mm ²)]	0,032	0,034	0,035	0,038	0,041	0,044	0,046	0,048
	$\delta_{N\infty}$ -factor	[mm/(N/mm ²)]	0,042	0,044	0,045	0,049	0,053	0,056	0,059	0,062
Temperature range III: 160°C/100°C	δ_{N0} -factor	[mm/(N/mm ²)]	0,121	0,126	0,131	0,142	0,153	0,163	0,171	0,179
	$\delta_{N\infty}$ -factor	[mm/(N/mm ²)]	0,124	0,129	0,135	0,146	0,157	0,168	0,176	0,184
Cracked concrete C20/25 under static, quasi-static and seismic C1 action										
Temperature range I: 80°C/50°C	δ_{N0} -factor	[mm/(N/mm ²)]	0,081	0,083	0,085	0,090	0,095	0,099	0,103	0,106
	$\delta_{N\infty}$ -factor	[mm/(N/mm ²)]	0,104	0,107	0,110	0,116	0,122	0,128	0,133	0,137
Temperature range II: 120°C/72°C	δ_{N0} -factor	[mm/(N/mm ²)]	0,084	0,086	0,088	0,093	0,098	0,103	0,107	0,110
	$\delta_{N\infty}$ -factor	[mm/(N/mm ²)]	0,108	0,111	0,114	0,121	0,127	0,133	0,138	0,143
Temperature range III: 160°C/100°C	δ_{N0} -factor	[mm/(N/mm ²)]	0,312	0,321	0,330	0,349	0,367	0,385	0,399	0,412
	$\delta_{N\infty}$ -factor	[mm/(N/mm ²)]	0,321	0,330	0,340	0,358	0,377	0,396	0,410	0,424
Cracked concrete C20/25 under seismic C2 action										
All temperature ranges	$\delta_{N,eq(DLS)}$ -factor	[mm/(N/mm ²)]	NPA	0,120	0,100	0,100	0,120	NPA		
	$\delta_{N,eq(ULS)}$ -factor	[mm/(N/mm ²)]		0,140	0,150	0,110	0,150			
¹⁾ Calculation of the displacement $\delta_{N0} = \delta_{N0}\text{-factor} \cdot \tau$; $\delta_{N,eq(DLS)} = \delta_{N,eq(DLS)\text{-factor}} \cdot \tau$; τ : action bond stress for tension $\delta_{N\infty} = \delta_{N\infty}\text{-factor} \cdot \tau$; $\delta_{N,eq(ULS)} = \delta_{N,eq(ULS)\text{-factor}} \cdot \tau$;										
Table C9: Displacements under shear load¹⁾ (threaded rod)										
Anchor size threaded rod			M 8	M 10	M 12	M 16	M 20	M24	M 27	M 30
Non-cracked and cracked concrete C20/25 under static, quasi-static and seismic C1 action										
All temperature ranges	δ_{V0} -factor	[mm/kN]	0,06	0,06	0,05	0,04	0,04	0,03	0,03	0,03
	$\delta_{V\infty}$ -factor	[mm/kN]	0,09	0,08	0,08	0,06	0,06	0,05	0,05	0,05
Cracked concrete C20/25 under seismic C2 action										
All temperature ranges	$\delta_{V,eq(DLS)}$ -factor	[mm/kN]	NPA	0,27	0,13	0,09	0,06	NPA		
	$\delta_{V,ep(ULS)}$ -factor	[mm/kN]		0,27	0,14	0,10	0,08			
¹⁾ Calculation of the displacement $\delta_{V0} = \delta_{V0}\text{-factor} \cdot V$; V: action shear load $\delta_{V\infty} = \delta_{V\infty}\text{-factor} \cdot V$; $\delta_{V,eq(DLS)} = \delta_{V,eq(DLS)\text{-factor}} \cdot V$; $\delta_{V,eq(ULS)} = \delta_{V,eq(ULS)\text{-factor}} \cdot V$;										
Essve Injection system HY for concrete								Annex C 8		
Performances Displacements (threaded rods)										

Table C10: Displacements under tension load¹⁾ (rebar)												
Anchor size reinforcing bar			Ø 8	Ø 10	Ø 12	Ø 14	Ø 16	Ø 20	Ø 24	Ø 25	Ø 28	Ø 32
Non-cracked concrete C20/25 under static and quasi-static action												
Temperature range I: 80°C/50°C	δ _{N0} -factor	[mm/(N/mm ²)]	0,031	0,032	0,034	0,035	0,037	0,039	0,042	0,043	0,045	0,048
	δ _{N∞} -factor	[mm/(N/mm ²)]	0,040	0,042	0,044	0,045	0,047	0,051	0,054	0,055	0,058	0,063
Temperature range II: 120°C/72°C	δ _{N0} -factor	[mm/(N/mm ²)]	0,032	0,034	0,035	0,036	0,038	0,041	0,044	0,045	0,047	0,050
	δ _{N∞} -factor	[mm/(N/mm ²)]	0,042	0,044	0,045	0,047	0,049	0,053	0,056	0,057	0,060	0,065
Temperature range III: 160°C/100°C	δ _{N0} -factor	[mm/(N/mm ²)]	0,121	0,126	0,131	0,137	0,142	0,153	0,163	0,164	0,172	0,186
	δ _{N∞} -factor	[mm/(N/mm ²)]	0,124	0,129	0,135	0,141	0,146	0,157	0,168	0,169	0,177	0,192
Cracked concrete C20/25 under static, quasi-static and seismic C1 action												
Temperature range I: 80°C/50°C	δ _{N0} -factor	[mm/(N/mm ²)]	0,081	0,083	0,085	0,087	0,090	0,095	0,099	0,099	0,103	0,108
	δ _{N∞} -factor	[mm/(N/mm ²)]	0,104	0,107	0,110	0,113	0,116	0,122	0,128	0,128	0,133	0,141
Temperature range II: 120°C/72°C	δ _{N0} -factor	[mm/(N/mm ²)]	0,084	0,086	0,088	0,090	0,093	0,098	0,103	0,103	0,107	0,113
	δ _{N∞} -factor	[mm/(N/mm ²)]	0,108	0,111	0,114	0,118	0,121	0,127	0,133	0,133	0,138	0,148
Temperature range III: 160°C/100°C	δ _{N0} -factor	[mm/(N/mm ²)]	0,312	0,321	0,330	0,340	0,349	0,367	0,385	0,385	0,399	0,425
	δ _{N∞} -factor	[mm/(N/mm ²)]	0,321	0,330	0,340	0,349	0,358	0,377	0,396	0,396	0,410	0,449
¹⁾ Calculation of the displacement δ _{N0} = δ _{N0} -factor · τ; τ: action bond stress for tension δ _{N∞} = δ _{N∞} -factor · τ;												
Table C11: Displacement under shear load¹⁾ (rebar)												
Anchor size reinforcing bar			Ø 8	Ø 10	Ø 12	Ø 14	Ø 16	Ø 20	Ø 24	Ø 25	Ø 28	Ø 32
For concrete C20/25 under static, quasi-static and seismic C1 action												
All temperature ranges	δ _{V0} -factor	[mm/kN]	0,06	0,05	0,05	0,04	0,04	0,04	0,03	0,03	0,03	0,03
	δ _{V∞} -factor	[mm/kN]	0,09	0,08	0,08	0,06	0,06	0,05	0,05	0,05	0,04	0,04
¹⁾ Calculation of the displacement δ _{V0} = δ _{V0} -factor · V; V: action shear load δ _{V∞} = δ _{V∞} -factor · V;												
Essve Injection system HY for concrete										Annex C 9		
Performances Displacements (rebar)												

Table C12: Displacements under tension load¹⁾ (Internal threaded rod)

Anchor size Internal threaded rod			IG-M 6	IG-M 8	IG-M 10	IG-M 12	IG-M 16	IG-M 20
Non-cracked concrete C20/25 under static and quasi-static action								
Temperature range I: 80°C/50°C	δ_{N0} -factor	[mm/(N/mm ²)]	0,032	0,034	0,037	0,039	0,042	0,046
	$\delta_{N\infty}$ -factor	[mm/(N/mm ²)]	0,042	0,044	0,047	0,051	0,054	0,060
Temperature range II: 120°C/72°C	δ_{N0} -factor	[mm/(N/mm ²)]	0,034	0,035	0,038	0,041	0,044	0,048
	$\delta_{N\infty}$ -factor	[mm/(N/mm ²)]	0,044	0,045	0,049	0,053	0,056	0,062
Temperature range III: 160°C/100°C	δ_{N0} -factor	[mm/(N/mm ²)]	0,126	0,131	0,142	0,153	0,163	0,179
	$\delta_{N\infty}$ -factor	[mm/(N/mm ²)]	0,129	0,135	0,146	0,157	0,168	0,184
Cracked concrete C20/25 under static and quasi-static action								
Temperature range I: 80°C/50°C	δ_{N0} -factor	[mm/(N/mm ²)]	0,083	0,085	0,090	0,095	0,099	0,106
	$\delta_{N\infty}$ -factor	[mm/(N/mm ²)]	0,170	0,110	0,116	0,122	0,128	0,137
Temperature range II: 120°C/72°C	δ_{N0} -factor	[mm/(N/mm ²)]	0,086	0,088	0,093	0,098	0,103	0,110
	$\delta_{N\infty}$ -factor	[mm/(N/mm ²)]	0,111	0,114	0,121	0,127	0,133	0,143
Temperature range III: 160°C/100°C	δ_{N0} -factor	[mm/(N/mm ²)]	0,321	0,330	0,349	0,367	0,385	0,412
	$\delta_{N\infty}$ -factor	[mm/(N/mm ²)]	0,330	0,340	0,358	0,377	0,396	0,424

¹⁾ Calculation of the displacement

$$\delta_{N0} = \delta_{N0}\text{-factor} \cdot \tau;$$

τ : action bond stress for tension

$$\delta_{N\infty} = \delta_{N\infty}\text{-factor} \cdot \tau;$$

Table C13: Displacements under shear load¹⁾ (Internal threaded rod)

Anchor size Internal threaded rod			IG-M 6	IG-M 8	IG-M 10	IG-M 12	IG-M 16	IG-M 20
Non-cracked and cracked concrete C20/25 under static and quasi-static action								
All temperature ranges	δ_{V0} -factor	[mm/kN]	0,07	0,06	0,06	0,05	0,04	0,04
	$\delta_{V\infty}$ -factor	[mm/kN]	0,10	0,09	0,08	0,08	0,06	0,06

¹⁾ Calculation of the displacement

$$\delta_{V0} = \delta_{V0}\text{-factor} \cdot V;$$

V: action shear load

$$\delta_{V\infty} = \delta_{V\infty}\text{-factor} \cdot V;$$

Essve Injection system HY for concrete

Performances

Displacements (Internal threaded anchor rod)

Annex C 10